

**Even if you didn't get one of these beauties
in your stocking, the improvements may well
benefit your present rig.**

Signal/One Transceiver Improvements

By ROBERT A. SULLIVAN,* WØYVA/4

One of the most sophisticated pieces of equipment to be made available for the amateur market was the SIGNAL/ONE transceiver, models CX7, CX7A, CX7B. These beautiful rigs contain just about every feature one might imagine and as such, are very complicated. Unfortunately they are no longer manufactured and it is difficult to obtain repair information. It appears that in the near future an updated version of the CX7 series will be made available as the CX11¹, but there is still a need for technical information to keep the numerous CX7 series units operational.

Over the years numerous problems have arisen with the CX7 that indicate the need for minor changes in design. This article describes numerous modifications that have proven useful additions to the CX7 in terms of operational reliability and convenience. The modifications described have been installed by numerous owners, including myself, with excellent results.

Because of the complexity of the CX7 it is suggested you do not tear into the rig without some previous electronics knowledge. If you do not feel qualified get someone to help you.² Detailed step-by-step instructions are not given for all the modi-

fications and it is assumed you have at your disposal the original technical manual or better still, the improved Thomas Advertising Company manual.³

Receiver Incremental Tuning (RIT)

Although the CX7 does provide an A/TO mode (transmitter frequency offset), no provisions for RIT were included. The circuit of figure 1 may be easily constructed on a small piece of vector board and mounted on a new potentiometer which replaces the existing FSK front panel potentiometer. Install and adjust as follows:

- (a) Remove the existing FSK pot and mount the new RIT pot (R3) in its place.
- (b) Connect white wire #10 on the arm of the FSK pot to the arm of R3 (This will allow RIT with VFO B).
- (c) Blue wire #52 is —15 volts and may be used for the —15 volt supply to the vector board assembly.
- (d) Add new wires for +5 volts, ground, and R/T line. Route as required.
- (e) Turn RIT on and adjust R3 for the center of the frequency range and put the knob on so the pointer is at 12 o'clock.

*P.O. Box 6216
Arlington, VA 22206

¹Details concerning the CX11 are available from Payne Radio, Springfield, Tennessee or from the SIGNAL/ONE Corporation, Box 127, Franklin Lakes, New Jersey, 07417.

²Write to the author for suggestions for help or for additional information on the modifications.

³This manual is available from the author or directly from Thomas Advertising Company, 715 Silver Spring Road, Suite 210, Rolling Hills Estates, California, 90274.

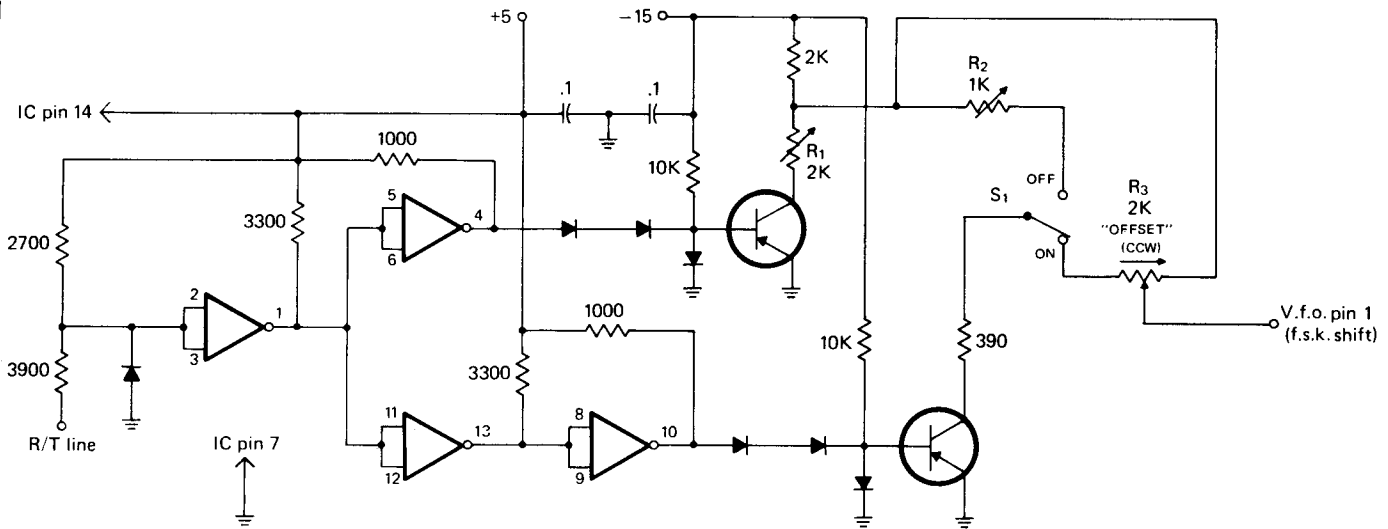

Fig. 1—Receiver offset tuning schematic. The IC is an SN7401, all diodes are 1N4148, transistors are 2N2907. Switch S1 is mounted on R3, the new offset control. All potentiometers have a linear taper.

(f) Turn RIT off and adjust R2 for the same frequency as read in the above step.

(g) Key transmitter and adjust R1 for this same frequency.

This modification will provide approximately $\pm 4\text{kHz}$ of offset. VFO A may also be used with the RIT modification. If this is desired, an additional wire would have to be routed between VFO A and the new RIT board.

Additional Cooling

This is a **must!** Although the CX7 utilizes a massive heat sink at the rear panel for the 8072 final, additional cooling is required for reliable operation. Place a small muffin fan on top of the cabinet midway between the final cage and power transformer. It is also desirable to mount a 4×4 inch aluminum shield between the final cage and power transformer to act as a heat shield.

Protection For Counter Board Against Inadvertent High Voltage

Certain failures will allow the counter board to see +1500 volts on the +300 volt line which will damage nearly every semiconductor on this board. A simple modification will prevent this damage by blowing a fuse. (This modification is not required by those rigs using the newer LED boards such as the one provided by Cunningham, K0HHP). Install the circuit of fig. 2. If the +300 volt line rises to a high value, the zeners will conduct and cause the fuse to open.

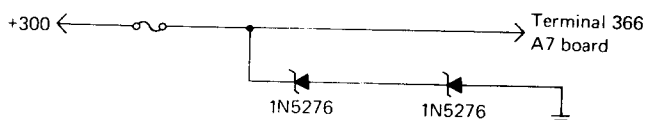

Fig. 2 — Counter board high-voltage protection.

Final Tube Protection

Fuse the screen at .05 amp. A fuse holder may be installed on the rear panel. Access to the screen lead is at the feedthroughs located on the final cage.

Parasitic Oscillations

Most parasitics will be cured by placing a single ferrite bead on each of the grid and screen terminals at the 8072 socket.

Reducing Intermodulation Products On Strong Signals

When in the A/TO transmit mode, both of the 35 MHz oscillators are running when in the receive mode, resulting in intermodulation products on strong signals. The following change will shut the offset oscillator off except in Spot or Transmit modes:

Connect a diode (1N914, etc.) on S2 board with cathode to A/TO switch (S2B) pin 12 and anode to Spot switch (S2E) pin 17.

Preventing RF Driver Board Damage

If coupling capacitor C30 fails with an 8072 plate-to-grid short, 1800 volts will appear on the driver board! Additional protection can be obtained by replacing the present 1 kV unit used for C30 with a 3 kV disc of the same value.

Installation Of MFJ CWF-2 Filter

Narrow c.w. filters are difficult to obtain for the CX7 and are quite expensive. The little c.w. filter by MFJ does an excellent job and can be mounted inside the rig and switched with the Mode switch. No external mechanical modifications are required. Bandwidths of 70, 110, and 180 Hz are provided and are selected in the FSK, CW3, and CW2 positions of the Mode switch respectively. (The CW1 position pro-

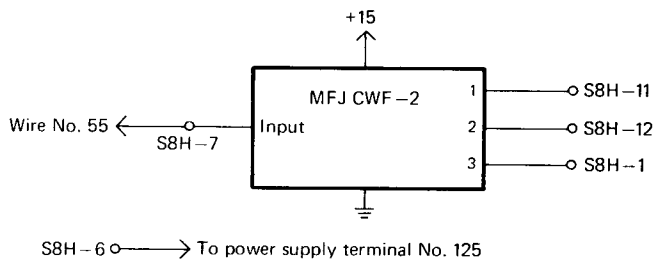

Fig. 3 — Connection diagram for MFJ CW Audio Filter. Switch identification numbers are from Thomas manual, Fig. 6-1.

vides the normal 2.1 kHz bandwidth.) Mount the unit near the Mode switch (I used one of the brackets near the filters at the rear end of the Mode switch) and perform the following step-by-step. See fig. 3.

- (a) Remove wire #355 from S8H-7.
- (b) Remove wire #185 from S8H-6.
- (c) Solder wire #355 to wire #185 and properly insulate the splice.
- (d) Install a jumper from S8G-6 to S8G-7. (Wire #184 is connected to S8G-6 and wire #353 is connected to S8G-7.)
- (e) Mount the MFJ filter in a convenient location near the mode switch.
- (f) Connect the MFJ filter "+" to any point in the +15 volt line.
- (g) Connect the MFJ ground to any ground location.
- (h) Remove coax #35 (audio input to terminal #125 on power supply board) and connect to S8H-7. Coax #35 will not reach this switch terminal and therefore will have to be extended. Shielded wire is not required for this extension. Hookup wire will do.
- (i) Connect MFJ filter input to S8H-7 (same terminal as in step h).
- (j) Connect a new wire from S8H-6 to terminal #125 on power supply board.
- (k) Connect MFJ filter output #1 to S8H-11 (180 Hertz output).
- (l) Connect MFJ filter output #2 to S8H-12 (110 Hertz output).
- (m) Connect MFJ filter output #3 to S8H-1 (70 Hertz output).
- (n) Clip jumper from S8H-12 to S8H-1. (The jumpers between S8H-7, 8, 9, and 10 should be left in place.)

The installed 2.1 MHz filter is still utilized for AM, L.S.B., U.S.B., and CW1 positions of the Mode

Fig. 4—Updated output stage using the National LM380 integrated circuit. Terminal #130 from the power supply board should go directly to the speaker jack.

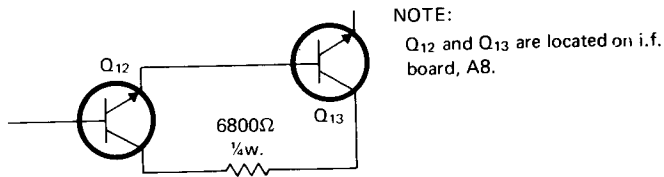
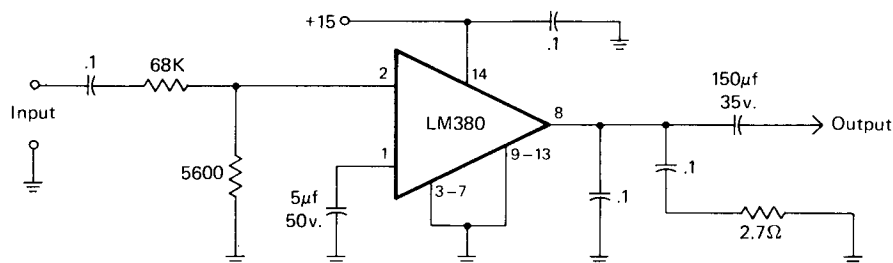

Fig. 5 — Improved a.g.c. action modification showing the addition of the 6800 ohm resistor.

switch. Note that with this modification installed no auxiliary filters can be used.

Improved Audio

The CX7 is a bit shy on audio output especially at the narrow bandwidths when using an audio filter. Furthermore, the audio output integrated circuit used in most units (PA237) is no longer available. The circuit shown in fig. 4 will provide more and cleaner audio than is presently available and do it with considerably less parts. This modification can replace the PA237 or the MFC9020 integrated circuit used on some units. Build the circuit of fig. 4 on a small piece of vector board and then perform the following steps:

- (a) Remove the existing audio output integrated circuit and associated components. (Be sure to remove C17.)
- (b) Mount the new output stage board adjacent to the power supply board and as near as possible to terminal #125.
- (c) Run wires for ground and +15 volts to the new board from the power supply board.
- (d) Disconnect the small coaxial cable from terminals 125 and 126 on the power supply board and connect to the new board input terminals.
- (e) Clip and insulate wire from terminal 130 on power supply board and run a new wire from the output of the new board directly to the speaker output jack. (The output transformer is no longer used, however it may be retained at the expense of some audio output if 600-ohm output is still desired.)

Note: Since the 24-volt supply is no longer used when this modification is made, the parts associated with this supply may be removed. These are Q11, Q10, R22, R30, and C18 on the power supply board.

Improved AGC

The addition of a single resistor as shown in fig. 5

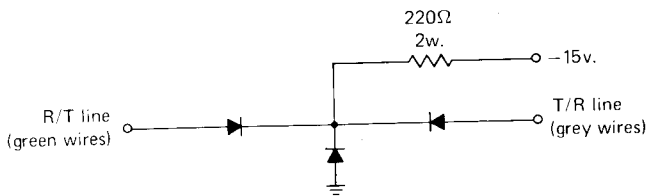

Fig. 6 — Schematic of diode network to eliminate frequency shift when switching from one transmit VFO to the other.

will eliminate loud pops in receive due to AGC action. Q12 and Q13 are located on the i.f. board, A8.

Reducing Frequency Shift When Switching V.F.O.'s

Adding the network shown in fig. 6 will nearly eliminate the frequency shift exhibited when switching from one transmit v.f.o. to another. The most convenient place to mount the network is near the power supply board where T/R, RT, and —15 volt lines are available. (All R/T lines are colored green and all T/R lines are colored gray.)

Power Supply Modification

Most failures in the CX7 are associated with the power supply board. (CX7 and CX7A.) The CX7B power supply was redesigned to utilize solid-state regulators which greatly reduced power supply complexity. It is an easy matter to modify the CX7 and CX7A power supply boards to use these regulators. One each of the Motorola MC7815, MC7915, and MC7805 regulators are required. Perform the following step-by-step:

- (a) Remove Q1, Q2, Q3, Q4, Q7, and Q8 from the existing power supply board.
- (b) Run a wire through the board where the emitters of Q2, Q3, Q4, and Q8 were originally. Solder the top end of the wire to the ground plane and the lower end to the original emitter line.
- (c) Install a jumper wire across R12.
- (d) Install a jumper wire across R21.
- (e) Install a jumper wire from the junction of R10 and R11 to pin 174 which is the low voltage side of R13.
- (f) Install a jumper wire from the junction of R19 and R20 to pin 171 which is the low voltage side of R22.

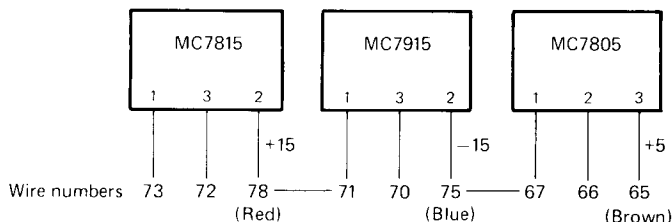

Fig. 7 — Connections for Motorola solid-state regulators.

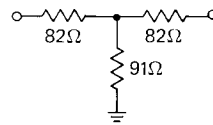

Fig. 8—Resistor pad to replace 8-pole filter. (all resistors are one-half watt).

(g) Replace existing R29 with a 7.5-ohm, 10-watt unit.

(h) Install an MC7815 in place of Q1, an MC7915 in place of Q2, and an MC7805 in place of Q3. (These units are located on the rear panel.) The MC7815 and MC7805 are bolted directly to the chassis but MC7915 must be insulated (use insulating hardware that was used with Q2). Use plenty of thermal compound. Wire the new transistors as shown in fig. 7.

(i) Install a 5 to 25 uf, 25-volt electrolytic from the low voltage side of R29 to ground. (To prevent MC7805 from oscillating.)

Increased Frequency Response On S.S.B.

Some of the CX7 units exhibit a narrow response in receive, making tuning difficult. This is caused when the two 8-pole filters are not flat. The solution is to remove one of them and replace with the simple pad shown in fig. 8. The removal of one of the filters does not seem to degrade the performance of the unit in any way.

Variable C.W. Sidetone

For those operators who tire of the same sidetone pitch, the addition of a potentiometer and single resistor wired as shown in fig. 9 will provide variable c.w. sidetone. The new potentiometer can be installed as a dual concentric unit with the existing CW Speed control on the front panel.

Although the modifications described were developed for the Signal/One transceiver, they would be useful for other rigs. The use of a small fuse and zener diodes (fig. 2) is an inexpensive way to provide overvoltage protection; the MFJ c.w. filter is an excellent addition to any transceiver; the circuit of fig. 4 is a useful audio amplifier for a variety of applications. Finally, additional cooling is generally indicated for almost every transceiver and will help ensure long-term trouble free performance.

Some simpler schemes for Receiver Incremental Tuning (RIT) have recently come to my attention. Two are described here. The first by K6BE, utilizes

(continued on page 72)

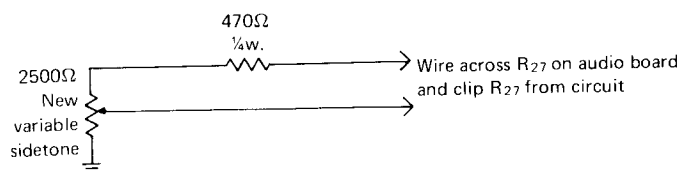

Fig. 9 — Schematic for variable sidetone modification.

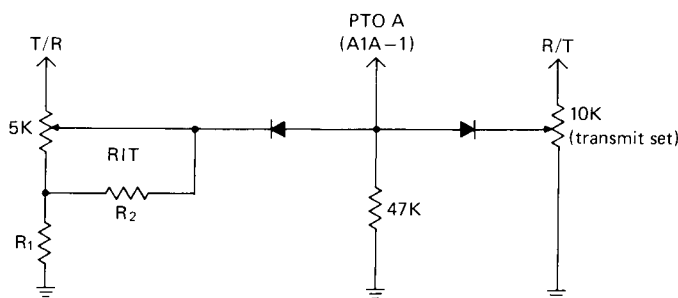

Fig. 10—K6BE RIT scheme.

the existing FSK potentiometer. No switch is used to turn RIT on/off since the total range is ± 1 kHz and is resettable to zero (The "I" in "RIT" on the panel!) to within 10 Hz. See circuit below. All components are mounted on a small terminal strip soldered and epoxyed to the rear of the FSK potentiometer. R1 is selected for the range desired and is selected at the low end of PTO range. Range of RIT is slightly more at the higher frequencies. R2 is selected to obtain centering of range at center of RIT control rotation. Typically R1=4700 and R2=1000 for a range of ± 1 KHz. The Xmit Set potentiometer is a miniature trimmer type. Diodes are 1N456 or similar.

An RIT scheme, by W7IV, has slightly more range and utilizes a switch mounted in a small external minibox. See circuit below. Connect terminal 1 of VFO A, the FSK varactor, to a pin on external connector J5 (accessories connector on rear panel). Many of the present connections to this connector would never be used, such as Front-end a.g.c. Disconnect one of these to free a pin. All other necessary connections (T/R, R/T, and -15 volts) are already on J5. The RIT potentiometer and components are all assembled into a small minibox and placed near the CX7.

My sincere thanks to all those who have written me with these modification ideas and to those who have reported their experiences with the modifications. Special thanks to K0HHP, W8IPA, W2SIL, W0NVE, and WB4RSK. This article would not have been possible without the efforts of Suzanne Jones who carefully deciphered my notes and typed the manuscript. ■

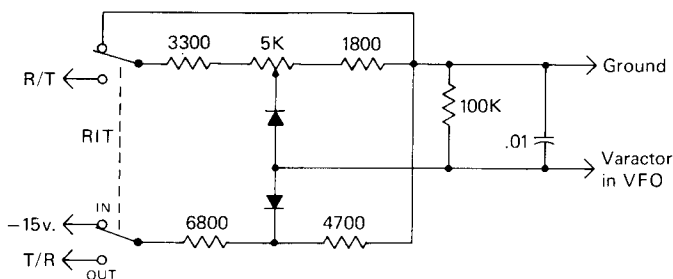

Fig. 11—W7IV RIT scheme.

connected to the p.c. board connectors. Masking tape, or gummed paper tape can be marked and taped to the loose ends of such wires until they are to be connected to the proper external points of the system.

In wiring up the interconnecting subsystems don't forget to allow for the correct wire size in those cases where heavy currents are expected. It is good practice to use heavy buss wire or buss bar for all ground returns. Some of the IC's in use today cause very sharp switching transients, or spikes, on the power lines and ground return. The heavy ground return buss wire will help in minimizing spikes. When running power lines to the various p.c. boards, or subsystems, it is a good idea to use ferrite beads and 0.1 mf. disc capacitors at the point of entry of the d.c. power to each board on which high transient spikes are anticipated. In addition, signal lines and switching lines carrying high speed clock pulses should be coax cable such as RG-174U. Best results occur when both ends of the coax cable are grounded. Noisy interference can be run down with an oscilloscope. This will be covered in the check out procedure which follows. When the power supply is remote from the system, be certain that the cable connecting the two is sufficiently heavy to prevent excessive voltage drop through the cable. Reference to the copper wire table^{4b} will indicate the size wire needed in the power cable.

System Checkout

After completing the wiring of the IC system, overall system checkout can be accomplished in an orderly manner by setting up and following a progressive routine. Upon completion of system wiring, it is well to perform a visual inspection of all wiring to ensure that there are no loose or unconnected wires. Where plug-in p.c. boards are used it's suggested that the pinout wires be checked for good solder connection and correctness of interconnection. Install all IC's in their sockets. Be certain that they are installed correctly (many IC's have been lost because they were installed backward). Install all p.c. boards in their corresponding sockets, again being careful that the boards are installed correctly and not backward. Recheck to be certain that the p.c. boards are in the correct sockets and plugged in correctly. To assist in correct installation of p.c. boards that do not have keyways, identify one end of each board with a spot of paint or tape and use the same identifying spot, just below the p.c. board, on the chassis or subassembly. Many IC's have been lost, along with other components, due to reversed installation of p.c. boards. This problem is generally eliminated on commercial systems by the use of keyways to allow installation of the p.c. board in only one direction. After completing the