

# *Panoramic Handbook*

for

## **PANADAPTOR**

**MODEL PCA-2**

**TYPE T-200**



**PANORAMIC**



**RADIO PRODUCTS, INC.**

10 SOUTH SECOND AVENUE  
MOUNT VERNON, NEW YORK

# TABLE OF CONTENTS

Paragraph	Title	Page
SECTION I. — GENERAL DESCRIPTION		
1.	Introduction .....	1
2.	General .....	1
3.	Cables .....	2
4.	Operating Controls. (Front Panel) .....	2
5.	Service Controls. (Rear Chassis Apron) .....	3
SECTION II. — INSTALLATION		
1.	Pre-Installation Check .....	3
2.	Location .....	4
3.	Connection of the PANADAPTOR to the Companion Receiver .....	4
4.	Connection of Audio Amplifier .....	6
5.	Adjustments .....	6
SECTION III. — OPERATION		
1.	Visible Panoramic .....	6
2.	Audible Panoramic .....	12
3.	Visible Single-Signal .....	12
4.	Audible Single-Signal .....	12
5.	Reception with the Panadaptor (Panoramic Method) .....	13
6.	Automatic Visual Monitoring .....	13
7.	Automatic Aural Monitoring .....	14
8.	Three-Way QSOs .....	14
9.	Watching for CQs .....	14
10.	Spotting Replies to your CQs .....	14
11.	Netting Operations for Traffic or Emergency .....	14
12.	Selecting QRM Free Spots .....	15
13.	Locating Stations Whose Exact Frequencies Are Unknown .....	15
14.	Instantaneous Signal Strength ("S") Meter for Phone and CW .....	15
15.	Measuring Percentage Modulation (AM) .....	17
16.	Spotting Distortion (AM Signals) .....	17
17.	Spotting Spurious Supersonics and R.F. Parasitics .....	18
18.	Detecting Splatter and Carrier Shift .....	19
19.	Detecting Frequency Drift .....	19
20.	Investigating CW Signals for Key Clicks .....	19
21.	Checking and Adjusting Frequency Deviation of FM Signals .....	19
22.	Identifying AM on FM Signals .....	21
23.	Detecting Residual Hum on a Carrier .....	22
24.	Frequency Setting and Measuring .....	22

## TABLE OF CONTENTS—Continued

Paragraph	Title	Page
SECTION IV.—CIRCUIT DETAILS		
1.	R.F. Section .....	24
2.	Converter, Local Oscillator and Reactor .....	25
3.	I.F. Amplifier .....	26
4.	Detector, Pulse AGC. and Video Amplifier .....	26
5.	Sawtooth Generator and Amplifier .....	26
6.	Power Supply and Panoramic Indicator Circuit .....	27
7.	Schematic Diagram .....	27
SECTION V.—MAINTENANCE AND SERVICE		
1.	Alignment .....	27
2.	Removal and Insertion of the Cathode-Ray Tube .....	29
3.	Trouble Shooting Chart .....	30
4.	Voltage Chart (Voltmeter 1,000 ohms per volt) .....	31
5.	Voltage Chart (Voltmeter 20,000 ohms per volt) .....	31
6.	Resistance Chart .....	32
7.	List of Special Components .....	32

## LIST OF ILLUSTRATIONS

Figure	Title	Page
1.	Portion of the Radio Frequency Spectrum .....	1
2.	Typical Picture of a Signal Shown in Visible Single-Signal Operation (Overmodulated Tone Signal) .....	2
3.	Main Operating Controls .....	2
4.	Service Adjustment Controls .....	3
5.	Cable Fabrication for Receivers Without PAN Outlet .....	5
6.	Typical Panoramic Picture of a 200KC Portion of a Band .....	6
7.	Determination of Signal Frequency at Maximum Sweepwidth .....	7
8.	Contrast of an Unmodulated Carrier with an AM Signal .....	8
9.	Typical Patterns of Single Side Band and FM Signals .....	9
10.	Comparison of CW and MCW Signals .....	9
11.	Visual Separation of Two Interfering Signals by Reducing the Sweepwidth .....	10
12.	Direction of Travel of Images Against Regular Signals as Receiver is Tuned .....	11
13.	Behavior of Deflections of Harmonics Compared with Deflections of Regular Signals as Receiver is Tuned .....	11
14.	Visual Appearance of a Signal Through Synchronous Noise .....	13
15.	Location of a QRM—Free Spot .....	15
16.	Calibration of Panoramic Screen for Instantaneous “S” Readings .....	16
17.	Calibration of Panoramic Screen for Percentage of Modulation .....	16
18.	Variation of Height of Modulation Pattern Against Modulating Frequency .....	17
19.	Distortion of a Tone Modulated Signal Due to Overmodulation, Peaks are Clipped at Baseline .....	18
20.	Distortion of Tone Modulated Signal Due to Poor Modulation Characteristics .....	18
21.	Typical Pattern of a Signal Modulated by a Supersonic Parastic at a Lower Frequency than Carrier .....	18
22.	Carrier Shift and Splatter .....	19
23.	Patterns of Key Clicks .....	20
24.	Instantaneous Display of Frequency Deviation of $\pm 15\text{KC}$ (SWEEPWIDTH set for $50\text{KC}$ ) .....	20
25.	Frequency Deviation of $\pm 75\text{KC}$ at a Modulation Frequency of $15\text{KC}$ .....	21
26.	Presence of AM on FM Indicated by a Non-Symmetrical Envelope Pattern .....	21
27.	Hum on Carrier .....	22
28.	F.M. Hum on Carrier Indicated by Phase Reversal of Hum Pattern as the Receiver or CENTER FREQ. Control is Tuned through a Station .....	22
29.	Frequency Setting with a Crystal Standard .....	23
30.	Frequency Setting with Secondary Standards .....	23
31.	Overall Response of PANADAPTOR and Receiver .....	24
32.	Overall Response at Reduced Preselector Selectivity and EQUALIZER Set for Minimum Equalization .....	25
33.	Distorted Overall Response Due to Mismatch Between PANADAPTOR Mean Input Frequency and Receiver I.F. ....	25
34.	Top View of Chassis .....	27
35.	Bottom View of Chassis .....	29
36.	Circuit Diagram, PANADAPTOR Model PCA-2, Type T-200 .....	33

## *Guarantee Notice*

The PANADAPTOR is guaranteed to be free from defects in material and workmanship.

Any parts exclusive of vacuum tubes, rubber and material normally consumed in operation giving evidence of defect in material or workmanship within ninety (90) days after receipt of complete equipment shall be replaced, provided we are notified in writing within a reasonable time and the defect is not the result of normal expected shelf life deterioration. Such written notice shall be sent to Panoramic Radio Products, Inc., 10 South Second Avenue, Mount Vernon, New York.

---

## *Factory Service*

Should the PANADAPTOR require any adjustment not covered in the Panoramic Handbook, we will be glad to assist you in any problem.

Should it become necessary to return the PANADAPTOR to the factory, a "Return Material Authorization" must be obtained in advance. Write, giving full details, to the *Service Department, Panoramic Radio Products, Inc., 10 South Second Avenue, Mount Vernon, New York.*

---

**THE PANADAPTOR IS NEW . . . DIFFERENT. PLEASE START IT OFF RIGHT  
BY FOLLOWING THESE FEW SIMPLE INSTRUCTIONS**

---

**PRELIMINARY INSTALLATION INSTRUCTIONS**

**INSTALLATION**

1. The receiver I.F. must lie within 450-470KC. See Section II, paragraph 5.
2. The PANADAPTOR requires 115V. 50-60 cycles power.
3. Attach the PANADAPTOR coaxial cable to the receiver converter tube *plate* pin.

**CAUTION**

High voltage or converter plate. Use care in making connection.

4. Turn power on by rotating the GAIN control clockwise. A baseline trace should appear on the screen in  $\frac{1}{2}$  minute.
5. Turn on the receiver. Adjust for normal operation.

**TESTING FOR NORMAL OPERATION  
OF THE PANADAPTOR**

1. Set the PANADAPTOR GAIN control to minimum (10).
2. The baseline should appear clear and sharp and coincidental with the lowest line on the screen. If necessary, adjust the screw driver controls, INTENSITY, FOCUS, VERTICAL POSITION, at the rear of the PANADAPTOR chassis. See Figure 4.
3. Set the SWEEPWIDTH to maximum (200), the GAIN to maximum (100), and the CENTER FREQ. to zero. The baseline will appear "grassy" with a slight "hump" at each end. Signals are indicated by inverted "V"s in the baseline.
4. Rotate the EQUALIZER control throughout

its range. The "humps" should change in height. Set to 100. This setting is satisfactory for most operations. Refer to the Section III, paragraph 1.

5. Rock the CENTER FREQ. control. The Panoramic picture should move correspondingly. Return control to zero. Allow the equipment to warm up for about ten to twenty minutes.
6. Select any signal. Bring it to the center of the screen by tuning the receiver. Turn the SWEEPWIDTH toward zero. The signal should expand on the screen with the peak remaining at the center line. Adjust the CENTER FREQ. control to keep the peak at the center. Reduce the GAIN to keep the signal below the saturation level. With the SWEEPWIDTH at zero, the signal will appear as a horizontal line across the screen. The CENTER FREQ. control is now at the *true zero setting*.
7. Plug in a pair of crystal earphones into the PANADAPTOR phone jack. The station should be the same as heard on the receiver.
8. Remove the phones and return the SWEEPWIDTH to maximum (200). If the signal is not under the center vertical line, use the HORIZONTAL POSITION control to bring them into coincidence.
9. Note the receiver dial setting. Move the receiver dial 100KC higher or lower and see if the signal is under the +100 or -100 marks on the screen. Regulate the GAIN to keep the signals visible. Make any necessary corrections to the sweep limits with the SWEEP PAD control. The tolerance is  $\pm 10$ KC. (+90 or -90 on the screen).

## SECTION I

### GENERAL DESCRIPTION

#### 1. INTRODUCTION.

The PANADAPTOR is a highly versatile piece of equipment. Its usefulness grows continuously as one's experience with it increases. It will make any good receiver better. But what the PANADAPTOR does and how it does it, is of course, determined by the receiver and the operator. The PANADAPTOR needs intelligent handling and careful interpretation of results.

The purpose of this handbook is to familiarize the operator with the operation, application and interpretation of Panoramic Reception, with PANADAPTOR Model PCA-2, Type T-200.

Please read the handbook carefully.

Complete Installation and Maintenance data for PANADAPTOR Model PCA-2, Type T-200, are provided in individual sections.

#### 2. GENERAL.

Through its many applications, the PANADAPTOR provides information and operating technique not obtainable in any other way. Upon connecting the PANADAPTOR to any standard communications receiver, both visible and audible reception of all signals receivable within the tuning range of the receiver are possible. The aural receiver used with Model PCA-2 must be a superheterodyne having an I.F. between 450KC and 470KC. It is preferable that this receiver have at least one R.F. stage for adequate image rejection.

##### Note

The PANADAPTOR is factory adjusted for a mean input frequency of 455 KC. For best results the mean input frequency of the PANADAPTOR should match the receiver I.F. If they do not match, the R.F. Bandpass Amplifier of the PANADAPTOR must be realigned according to Alignment Procedure Section V.

Six types of operation are available as follows:

*a.* **VISIBLE PANORAMIC.** Signals (within a band extending up to 100KC above and below the frequency to which the companion receiver is tuned) appear as individual vertical "pips", in order of frequency, at a definite location along the calibrated horizontal axis of the Panoramic screen.

As the receiver is tuned, the "pips" move across the screen and "walk-off" at one side while new pips enter on the opposite side. For any setting of the receiver tuning dial, the "pip" appearing at the *center or zero mark* of the screen represents the signal to which the receiver is tuned.

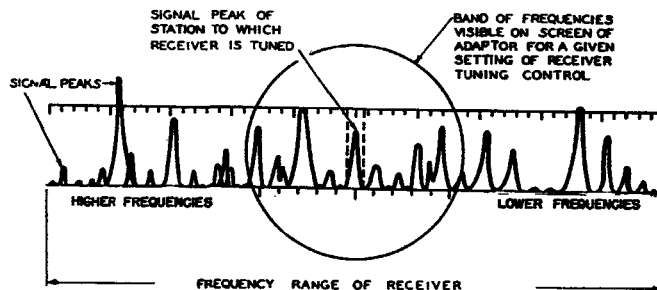

Figure 1. Portion of the Radio Frequency Spectrum

From the location of a "pip" and the receiver tuning dial setting, the frequency of the respective signal is determined. The height and behavior of a "pip" indicate relative signal strength and character, respectively.

When the PANADAPTOR is connected to some receivers with two or more stages of R.F., it may not be possible to observe up to 200KC at one time.

The visual bandwidth or sweepwidth can be reduced, at will, from 200 KC to 0 KC.

*b.* **AUDIBLE PANORAMIC.** An audio output jack at the rear of the PCA-2 enables audible reception of all receivable signals, at once, within a band of up to 100KC above and below the frequency to which the receiver is tuned.

The output level is more than adequate for headset operation. Speaker operation is obtainable with a supplementary external audio amplifier.

*c.* **VISIBLE SINGLE-SIGNAL.** Any one signal, within 100KC of the frequency to which the receiver is tuned, can be tuned in on the PANADAPTOR and shown on the Panoramic screen. Refer to Figure 2.

*d.* **AUDIBLE SINGLE-SIGNAL.** This operation is the same as Visible Single-Signal except that an audio output is provided through the rear phone jack.

e. **VISIBLE - AUDIBLE PANORAMIC.** This combined operation of Visible Panoramic and Audible Panoramic is available when the audio output of the PCA-2 is fed to high impedance headphones (crystal type) or to an external audio amplifier.

f. **VISIBLE-AUDIBLE SINGLE-SIGNAL.** This combined operation of Visible Single-Signal and Audible Single-Signal is possible when the audio output of the PCA-2 is fed to a high impedance. (See e. above).

### 3. CABLES.

Two cables are brought out of the rear chassis apron. A power cable terminated with a standard two pole plug and an R.F. input cable with an isolating resistor, spring connector, and alligator clip connected to the free end.

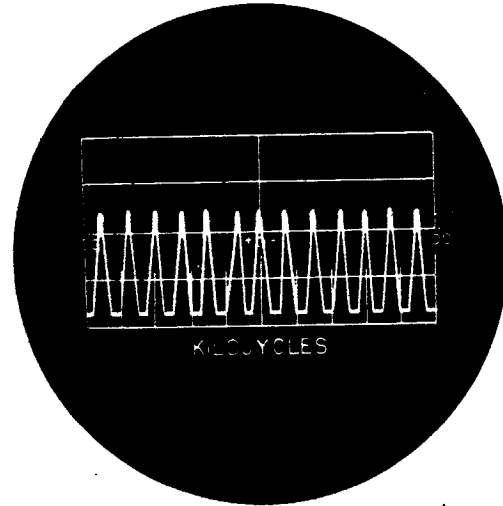

**Figure 2. Typical Picture of a Signal Shown in Visible Single-Signal Operation (Overmodulated Tone Signal)**

### 4. OPERATING CONTROLS. (Front Panel).

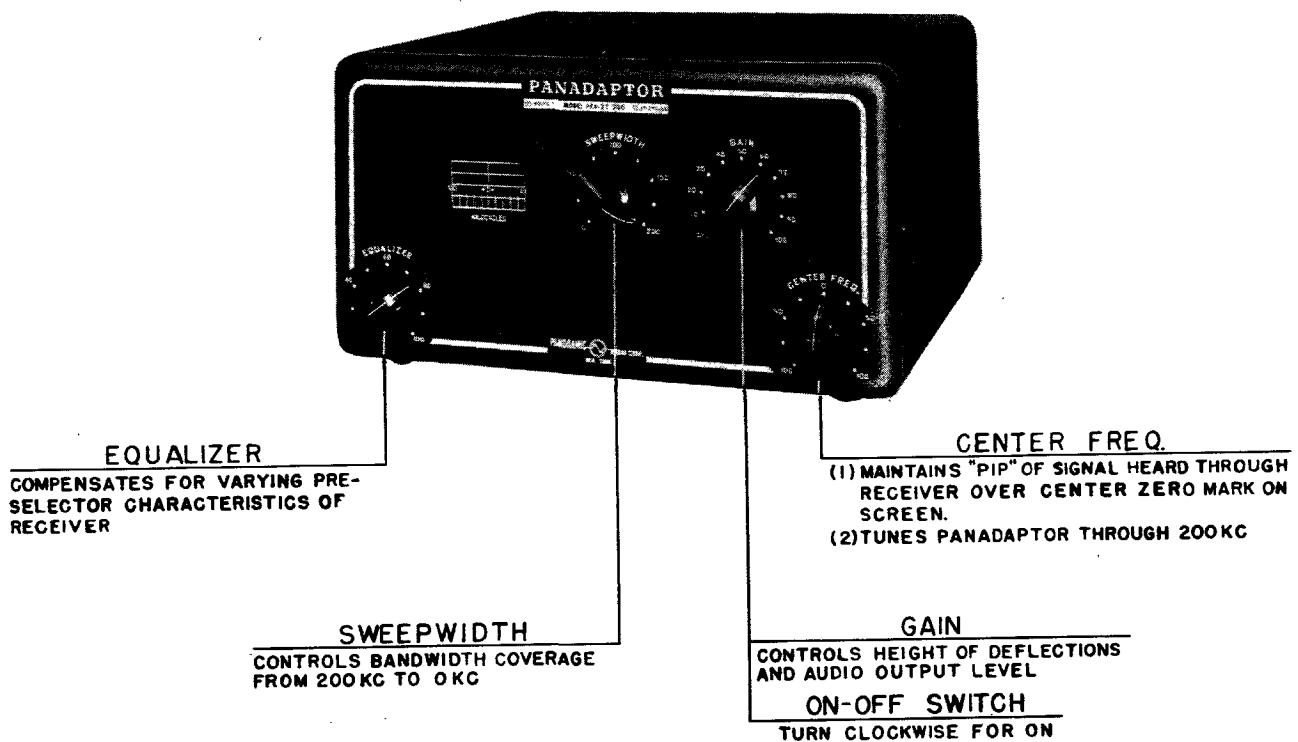

**Figure 3. Main Operating Controls**



## 5. SERVICE CONTROLS. (Rear Chassis Apron).

These controls seldom require adjustment.

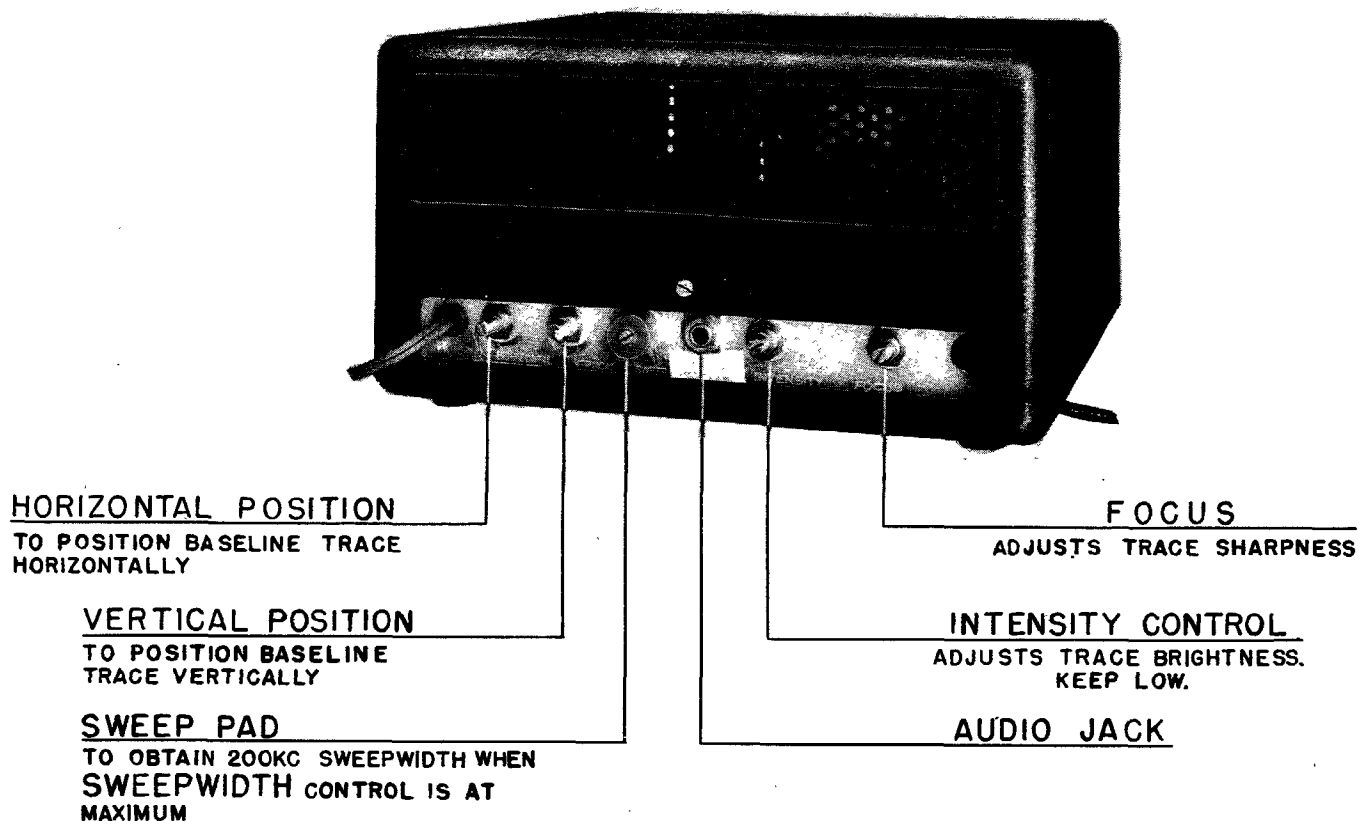

Figure 4. Service Adjustment Controls

## SECTION II INSTALLATION

The PANADAPTOR has been packed to withstand normal abuse in transit. It is recommended that, upon receipt, the carton and PANADAPTOR be examined carefully for any damage that might have occurred in transit.

### 1. PRE-INSTALLATION CHECK.

The PANADAPTOR operates on 115V, 50-60 cycles, single phase AC, with a power consumption of approximately 55 watts.

*Be sure that this power is available, then plug in the PANADAPTOR.*

Set the controls like this:

- EQUALIZER at 100
- SWEEPWIDTH at 200
- CENTER FREQ. at 0
- GAIN at 60 which also turns on the power.

In about half a minute the baseline trace should appear on the Panoramic screen.

If it does not, observe whether the tubes are lit by looking through the ventilation screen at the rear of the cabinet.

If they are *not* lit refer to the Trouble Shooting Chart, Section V.

If they are lit, adjust the INTENSITY, FOCUS, VERTICAL POSITION, and HORIZONTAL POSITION controls as outlined in the Alignment Procedure, Section V.

Turn the GAIN control to 100. . . . The ends of the baseline may break up into "grass" (noise). . . This is not abnormal. Back off the GAIN control to 10. . . The baseline should be clean from end to end.

## 2. LOCATION.

The PANADAPTOR may be mounted on a bench or table, but the best place is right on top of the receiver. In any case keep the ventilation holes of the receiver and PANADAPTOR clear.

If crowded for space, the PANADAPTOR can be mounted on its side. Turn the PANADAPTOR off. Remove the three chassis retaining screws around the front top and sides of the cabinet and the rear cabinet screw right above the audio jack.

Ease the chassis and front panel out of the cabinet by applying pressure to the rear of the chassis and rocking it from side to side.

Unscrew the mounting feet and replace them in the holes through the side of the cabinet.

Firmly grasp the magnetic shield around the Panoramic indicator and gently rotate it one-quarter turn counter-clockwise; the green disc will revolve with a shield.

The Panoramic indicator tube is turned a quarter turn, in the same direction, by rotating the tube socket at the rear of the bracket.

Turn on the equipment to check whether the baseline trace runs parallel to the engraved baseline on the green screen.

Reassemble the chassis and cabinet. For convenient side mounting, place the PANADAPTOR beside the receiver.

## WARNING

(Watch out for high voltages—do not make internal adjustments with the power on).

The specially processed green filter disc keeps external light off the face of the cathode-ray tube and provides a clear bright picture in a normally lighted room. For best results, keep excessive light off the screen.

## 3. CONNECTION OF THE PANADAPTOR TO THE COMPANION RECEIVER

*a.* SOLDERLESS CONNECTION.—The spiral catch spring and alligator clip on the RF cable enable a quick simple connection to receivers which do not employ loctal tube converters.

Although this type of connection will prove satisfactory, it is not the best for permanent use. It is recommended that the connection methods described in paragraphs *b* and *c*, below, be used.

The PANADAPTOR R.F. input cable is led, through the receiver cabinet, to the top of the chassis.

The converter tube (also known as the "mixer" or "1st detector" in some receivers) must be removed and the PLATE pin pushed through the eye of the spiral spring. The spring should bind the pin tightly.

The tube is *carefully* reinserted into the socket.

## CAUTION

This connection goes to B+ in the receiver. Avoid injury to the insulating sleeve so that no "shorts" develop between the connection and ground or another pin. The input I.F. transformer and other components in the receiver may burn out if this occurs.

## CONVERTER TUBE CHART

Type	Plate Pin No. *	Type	Plate Pin No. *
1A7	3	6L7	3
6A7	2	6SA7	3
6A8	3	6SB7	3
6J8	3	7Q7	2
6K8	3	12SA7	3

\* Looking at the bottom of the socket or at the base of the tube.

The alligator clip is fastened to a chassis ground point near the converter. Keep the connector and clip assembly close to the chassis to prevent oscillation, especially when the converter has a grid cap.

*b.* CONNECTION TO RECEIVERS NOT HAVING A PAN OUTLET.—It is best that a PAN connector be installed in the receiver to provide a simple permanent means of connecting or disconnecting the PANADAPTOR from the receiver.

A convenient location on the receiver chassis should be selected on which to mount the connector. This point should be located as near as possible to either the converter tube or a tie point of a lead running *directly* to the plate of the converter.

At this location the necessary mounting holes are drilled for the connector. If the connector does not come with a grounded solder lug, an appropriate lug should be included in mounting the connector.

A few suitable connectors are as follows:

Manufacturer	Connector	Associated Plug
Jones	S201	P201
Cinch	8134	M-93
ICA	2385	2383
Amphenol	83-1R	83-1SP

The length of cable, required between the connector and the plate prong of the converter socket or the tie point of the lead to the converter plate,

is clipped from the free end of the PANADAPTOR R.F. cable.

The metal sleeve at the end of the cable should be removed. A hot soldering iron is placed on the soldered end of the sleeve. As soon as the solder melts, the iron is removed and the sleeve is carefully withdrawn from the cable. The alligator clip is removed and the cable is prepared as shown in Figure 5 below.

The isolating resistor on the finished cable is soldered *adjacent* to the plate prong or tie point of the converter. This may require removal of a portion of the insulating sleeve on the resistor lead. The braid on the cable shield is soldered to a firm ground point. The inner conductor at the other end of the cable is soldered to the center pin of the connector and the shield grounding wire is tied and soldered to the connector grounding lug.

**Note**

If the distance between the connector and the converter tie point is very small, a 50,000 ohm, 1/4-1/2W resistor can be connected between the two points, and no cable inside the receiver is required.

The associated plug of the PAN connector is connected to the free end of the PANADAPTOR R.F. cable. The finished plug assembly should be tested for shorts before it is inserted into the PAN connector.

c. CONNECTION TO RECEIVER HAVING PAN OUTLET.—Receivers with a PAN connector have the necessary isolating resistor and a shielded cable installed. The *length* of this cable should be measured and the free end of the R.F. cable of the PANADAPTOR *shortened* by this amount.

Since the capacity of the R.F. cable is part of the input tuned circuit of the PANADAPTOR, the overall cable length must remain unchanged to prevent detuning. If the length is changed, the primary of the input transformer is readjusted by following the procedure for R.F. alignment in Alignment Procedure, Section V.

The associated plug to the PAN connector is connected to the end of the PANADAPTOR R.F. cable. These connectors are *not* furnished with the PANADAPTOR.

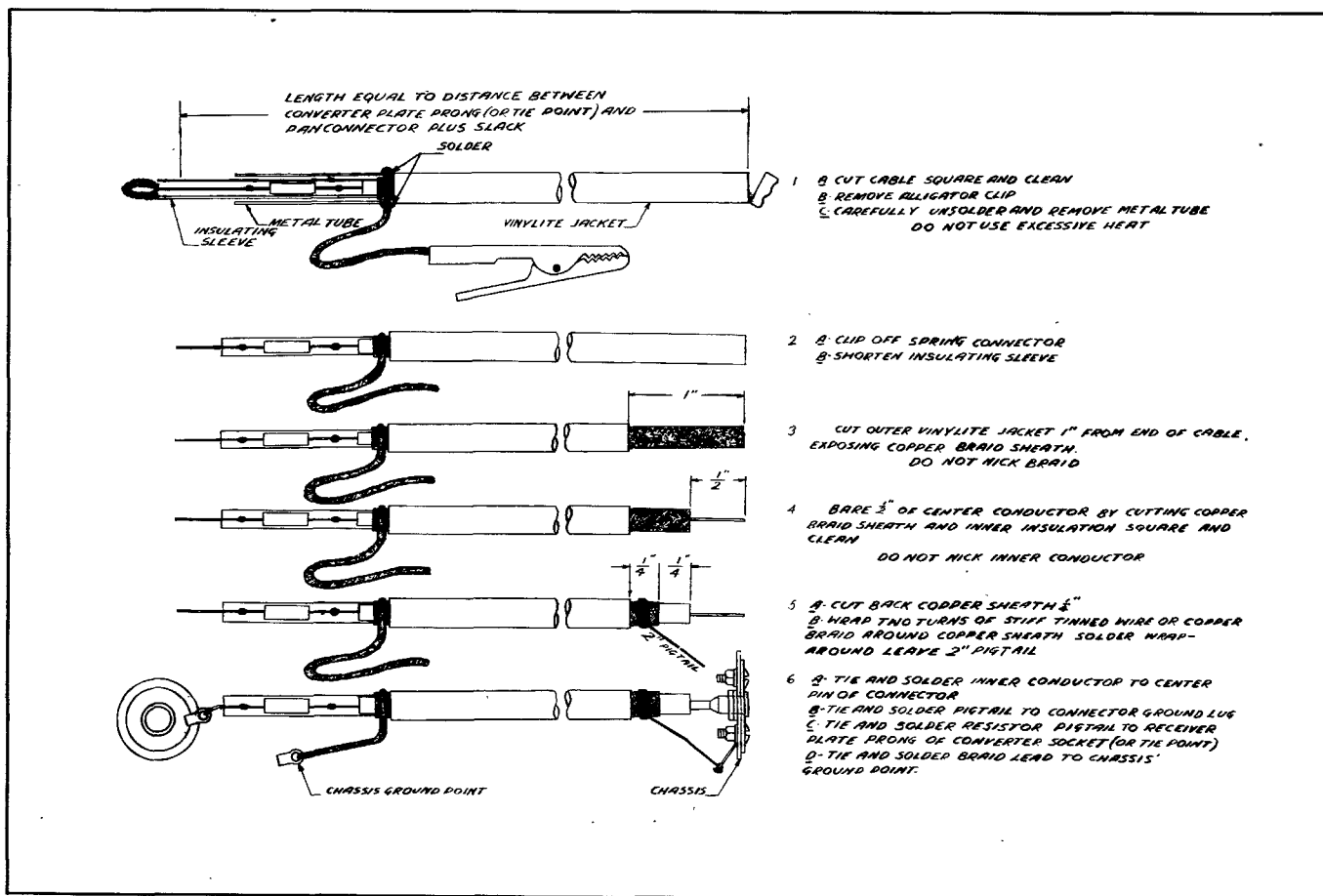

**Figure 5. Cable Fabrication for Receivers Without a PAN Outlet.**

#### 4. CONNECTION OF AUDIO AMPLIFIER.

If it is desired to use an external audio amplifier, it should be connected to the PANADAPTOR through the shortest possible length of a low capacity cable. The input grid return resistor of the amplifier must be greater than 470,000 ohms and the shunt capacity of the input must be held at a minimum to prevent distortion of the patterns on the Panoramic screen.

#### 5. ADJUSTMENTS.

When the PANADAPTOR is connected to a receiver having an I.F. other than 455KC (but lying between 450KC-470KC), the R.F. Bandpass Amplifier of the PANADAPTOR should be realigned to match the receiver I.F. Refer to Section V, Align-

ment Procedure. Slight adjustment of the F.M. oscillator and sweep linearity *may* be necessary.

If the PANADAPTOR is operated with a receiver having two or more stages of R.F., it may not be possible to observe up to 200KC of a band at one time. The extent of the observable bandwidth will vary with the particular band under examination. However, the bandwidth may be extended by realigning the R.F. Bandpass Transformers of the PANADAPTOR so that the peaking frequencies are *less* than  $\pm 90$ KC from the receiver I.F. (refer to Section V, Alignment Procedure, R.F. Bandpass Amplifier). The peaking frequencies to be used are determined, at the discretion of the operator, through adjusting and checking the R.F. Bandpass Transformers for maximum bandwidth coverage obtainable with the receiver in question. The screen calibrations are not affected by this adjustment.

### SECTION III OPERATION

The basic operating procedures for the PANADAPTOR are described below. These are followed by applications of single and combined procedures.

#### 1. VISIBLE PANORAMIC.

##### a. OPERATING PROCEDURE.

Turn on the receiver.

Set the RECEIVER controls, where applicable, approximately as follows:

R.F. Gain—Near maximum

A.F. Gain—Normal

A.V.C.—Off

Selectivity Control—Normal

Crystal—In or Out

B.F.O.—Off, for 'phone; On for C.W.

Noise Limiter—Off

Antenna Trimmer—Normal

Set the PANADAPTOR controls like this:

SWEEPWIDTH—200 (maximum)

CENTER FREQ.—0

GAIN—Approximately half way up (60).

This turns on the PANADAPTOR at the same time.

#### Operating Hint

Always keep the gain low so that the level of noise and spurious response is kept at a minimum. This makes it easier to check weak signals that are adjacent to strong ones.

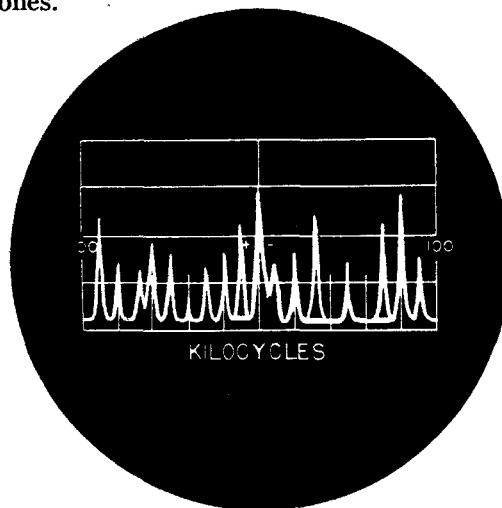

Figure 6. Typical Panoramic Picture of a 200KC Portion of a Band

Slowly tune the receiver. One or more signals should appear as inverted Vs along the baseline on the Panoramic screen. If they do not, it may be necessary to turn up the PANADAPTOR GAIN. The deflections move across the screen as the tuning dial is rotated. The signal heard through the receiver should appear directly over the center of zero mark on the screen. If this condition does not obtain, make the following adjustments.

Tune in either a voice or music modulated signal and center its deflection with the CENTER FREQ. Control. The deflection is easily identified by the way it bobs up and down in time with the music or voice when the SWEEPWIDTH is reduced. Slowly rotate the SWEEPWIDTH control to almost zero and at the same time trim the CENTER FREQ. control to maintain the broadening deflection centered.

Return the SWEEPWIDTH Control to maximum. The deflection should remain over the zero mark on the screen, but if it shifts off center, adjust the HORIZONTAL POSITION Control for final centering.

**The CENTER FREQ. Control may require adjustment to keep the deflection centered as the equipment "warms up."**

The HORIZONTAL POSITION requires only an occasional adjustment after it has been properly set.

Adjust the EQUALIZER Control so that the height of a "pip" remains as constant as possible as it passes across the screen while the receiver is tuned. Each band on the receiver may require a different adjustment setting of this control.

### IMPORTANT

If the preselector in the receiver is not properly aligned with the local oscillator, the peak of the receiver response, as it appears at the plate of the converter, may be located on either side of the receiver I.F. This will cause the overall response of the PANADAPTOR and receiver to be non-symmetrical. See Figure 33. Therefore, a "pip" may appear higher on one side of the screen than the other.

A non-symmetrical overall response may also occur if the I.F. of the receiver and

the mean input frequency of the PANADAPTOR do not match. (See Alignment Procedure, Section V).

In performing this adjustment and for general operation of the PANADAPTOR, it is best to cut off the AVC in the receiver since the signal appearing at the center of the screen may control the height of all other signals. Should the receiver be tuned to a strong signal, the weaker adjacent signals may be reduced in height, or they will not appear at all.

*b.* DETERMINATION OF SIGNAL FREQUENCIES.—As the receiver is tuned from a low to a high frequency, the signal deflections will move across the screen from left (+) to right (—). The reverse is true when tuning from a high to a low frequency.

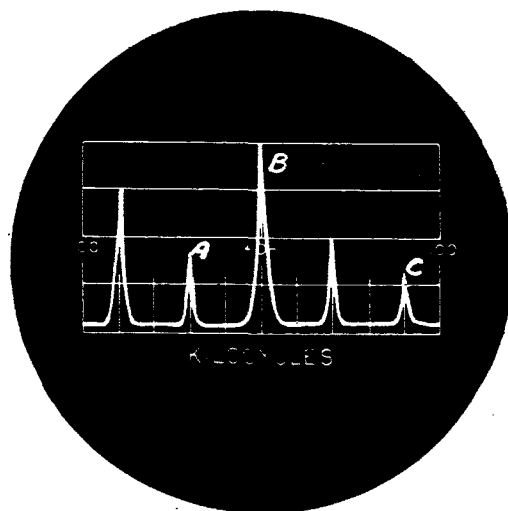

- A—Signal 40KC above signal heard through receiver.
- B—Signal heard through receiver.
- C—Signal 80KC below signal heard through receiver.

**Figure 7. Determination of Signal Frequency at Maximum Sweepwidth**

Those signals appearing on the (+) side of the zero mark are *higher* in frequency than the station heard through the receiver by the amount indicated by the screen calibrations. Each calibration mark, at *maximum sweepwidth*, is equal to 20KC.

Obviously, the signals appearing on the (—) side of the zero mark are *lower* in frequency than the station heard.

**Note**

The above is true only when a local oscillator in the receiver tracks at a *higher* frequency than the incoming signal. The signs are reversed when the receiver local oscillator tracks at a lower frequency than the incoming signal.

Determination of signal frequency is illustrated in Fig. 7.

c. INTERPRETATION OF SIGNALS.—With a little experience it is possible to recognize visually the character of the various types of signals, without the need of listening to them. It must be remembered, however, that the PANADAPTOR can show only what the radio receiver is able to receive and no more. A poorly adjusted receiver cannot be expected to give good results even with a perfectly adjusted PANADAPTOR.

(1) *An unmodulated constant carrier* appears as a deflection of fixed height.

(2) *An amplitude modulated carrier* appears as a deflection of variable height. Voice or music

modulation causes the height of the “pip” to vary irregularly.

At slightly reduced sweepwidth, a constant tone modulation of low frequency will produce a series of convolutions along the sides of the deflection. Their number is determined by the modulation frequency.

As the modulation frequency increases, the convolutions move toward the two sides of the deflection, and the sidebands tend to become visible. *When the modulation frequency is further increased, it becomes possible to separate the two side-band “pips” from the carrier “pip” by reducing the SWEEPWIDTH of the PANADAPTOR.* The higher the frequency of modulation the farther away these side-bands will move from the center deflection (representing the carrier).

(3) *Single side-band modulation* appears as two carriers of slightly different frequency. (See below: “Signal Interferences”). Refer to Figure 9.

(4) *A frequency shift signal* appears as a “pip” which “wobbles” sideways.

(5) *A speech or music modulated FM signal* appears as many deflections spreading over a variable bandwidth. During periods of audio silence a single carrier appears. Refer to Figure 9.

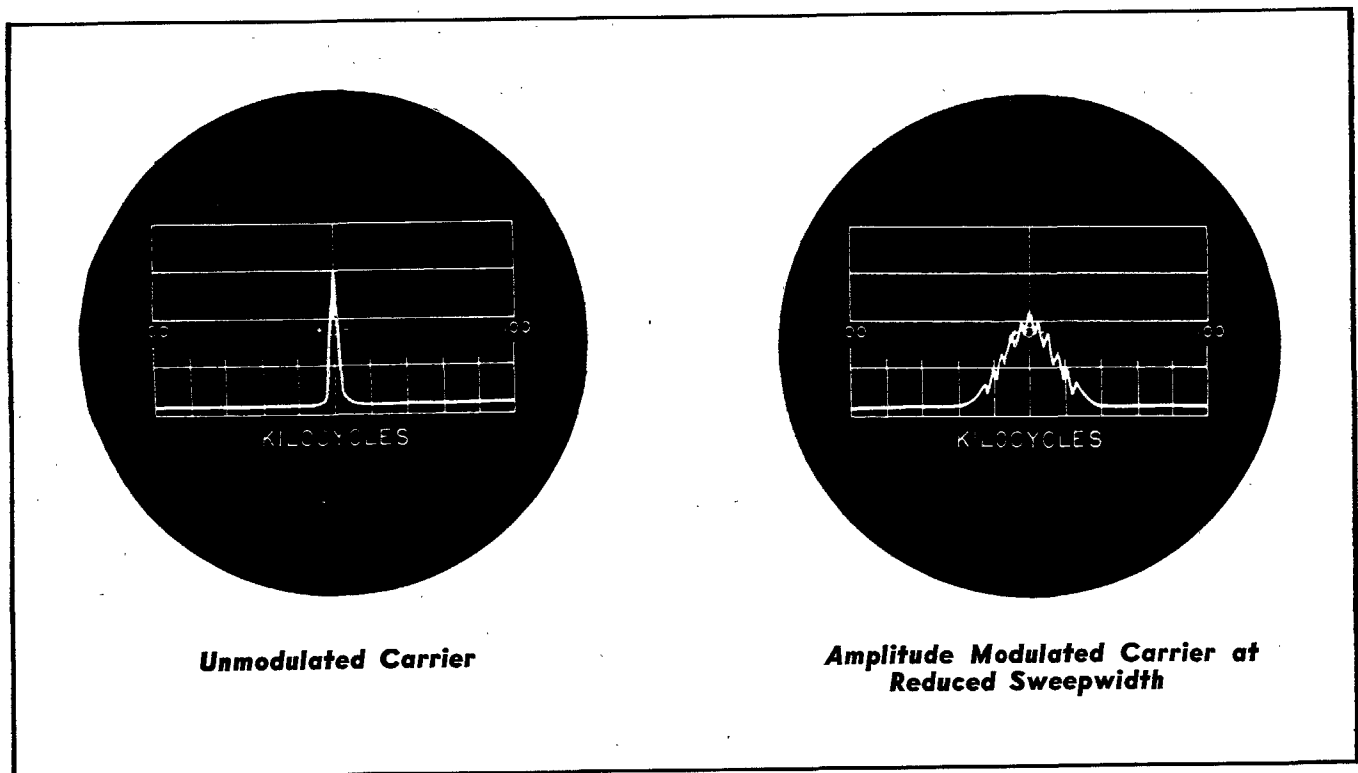

**Figure 8. Contrast of an Unmodulated Carrier With an AM Signal**

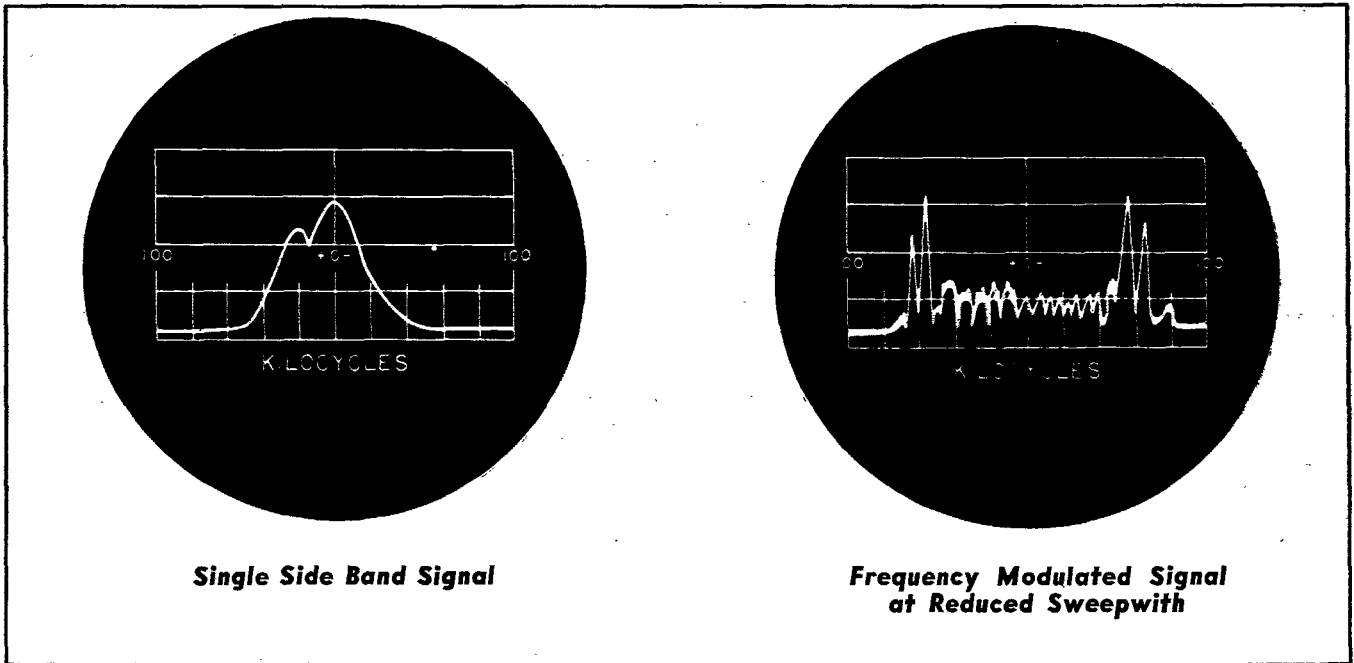

**Figure 9. Typical Patterns of Single Side Band and FM Signals**

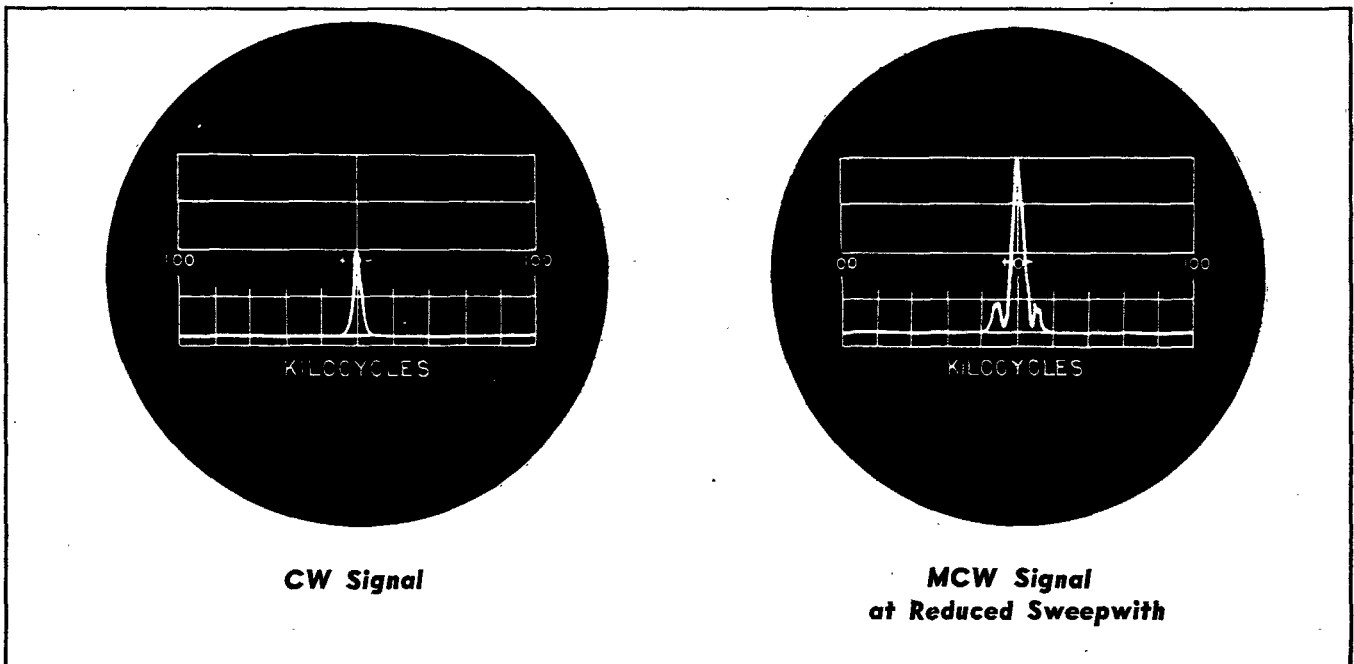

**Figure 10. Comparison of CW and MCW Signals**

(6) A CW signal "pip" appears and disappears in step with the keying of the transmitter. During the moments when the signal is off, the frequency sweep axis closes at the base of the signal. With a little practice, such signals can be read directly off the screen. In rapidly keyed signals the deflection and the base line are seen simultaneously.

**Note**

When the receiver BFO is on, it may produce a "pip" near the center of the screen. This is due to BFO pickup.

(7) An MCW signal appears like a CW signal of periodically varying height. If the modulation rate is high, side-bands will appear.

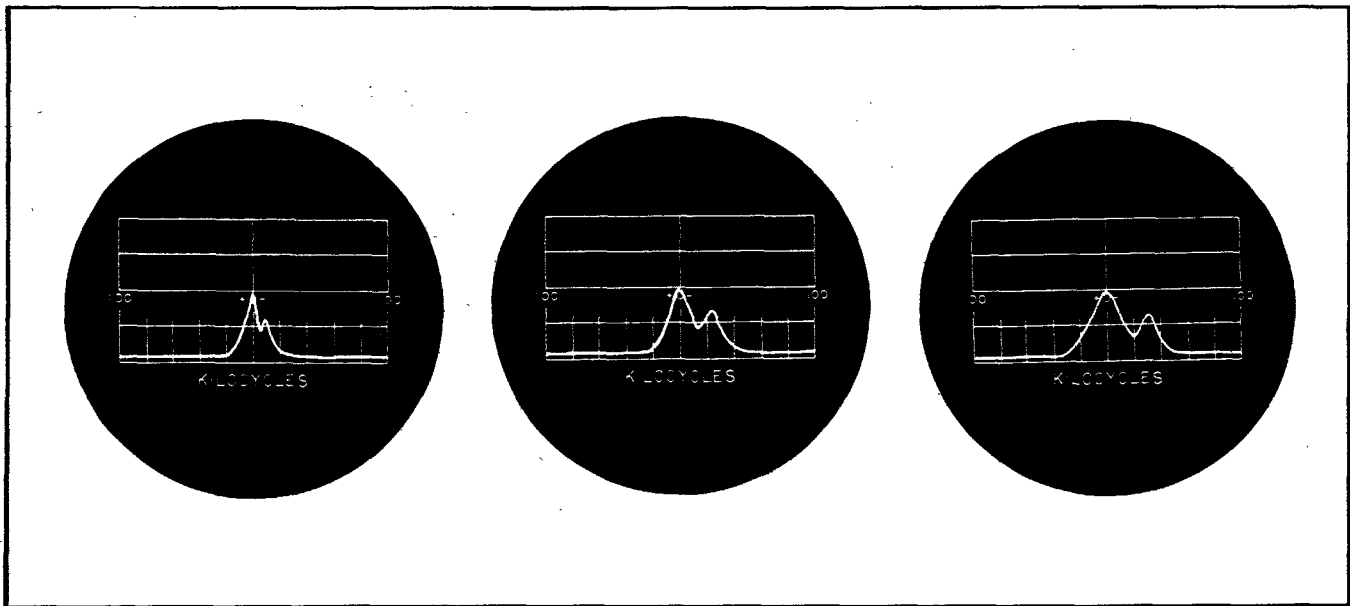

**Figure 11. Visual Separation of Two Interfering Signals by Reducing the Sweepwidth**

(8) *Signal Interference.* Two signals which are so close in frequency as to cause aural interference (beats) may appear on the screen as a single deflection, varying in height, as with a modulated signal. As the frequency separation is increased, the deflection appears as if modulated on one side only. Further increase of frequency separation will cause a "break" in the apex of the deflection. *By reducing the SWEEPWIDTH of the PANADAPTOR the respective deflection will gradually separate.*

(9) *Random noises,* generally received in the receiver, are of two types: periodic and aperiodic.

Periodic noises, such as produced by automobile ignition, motors, vibrators, buzzers, etc. appear as signals moving along the frequency sweep base line in one direction or another. Thus, an automobile which is accelerated will produce a set of deflections which may move first in one direction, slow down, stop, and then move in an opposite direction.

This is caused by the fact that the PANADAPTOR is sweeping at a fixed rate (25 or 30 times per second) whereas the transient occurs at a variable rate. The images stand still on the screen when there is synchronism between the two. If the periodic noise is synchronized with the 50 or 60 cycle line, the "noise" appears as a fixed signal which, how-

ever, does not move on the screen when the receiver is tuned, or when the SWEEPWIDTH is reduced to zero, but only varies in height. Such deflections may appear as amplitude modulated signals or as steady carriers. (See below: "Diathermy apparatus"). Aperiodic transients, such as "static", appear as irregular deflections and flashes along the whole frequency sweep axis.

(10) *Tube noise,* due to too great an amplification of the receiver, or PANADAPTOR, or both, appear as varying irregularities along the frequency sweep axis. Proper adjustment of the gain controls should reduce or eliminate this disturbance.

(11) *Images.* If the receiver allows "images" to pass (due to poor image rejection of the R.F. circuits), these will be distinguishable by the fact that they move in an *opposite* direction from normal signals, when the companion receiver is being tuned. Such images are most likely to appear on the higher frequency ranges of the receiver. Refer to Figure 12.

(12) *Spurious Signals.* If the signal strength exceeds a certain value, the deflection caused by any signals breaks up into a series of parallel reflections, somewhat similar to side-bands. These spurious signals can take place either in the receiver or PANADAPTOR on extremely strong signals. Turning down the gain of the PANADAPTOR will eliminate this type of distortion.



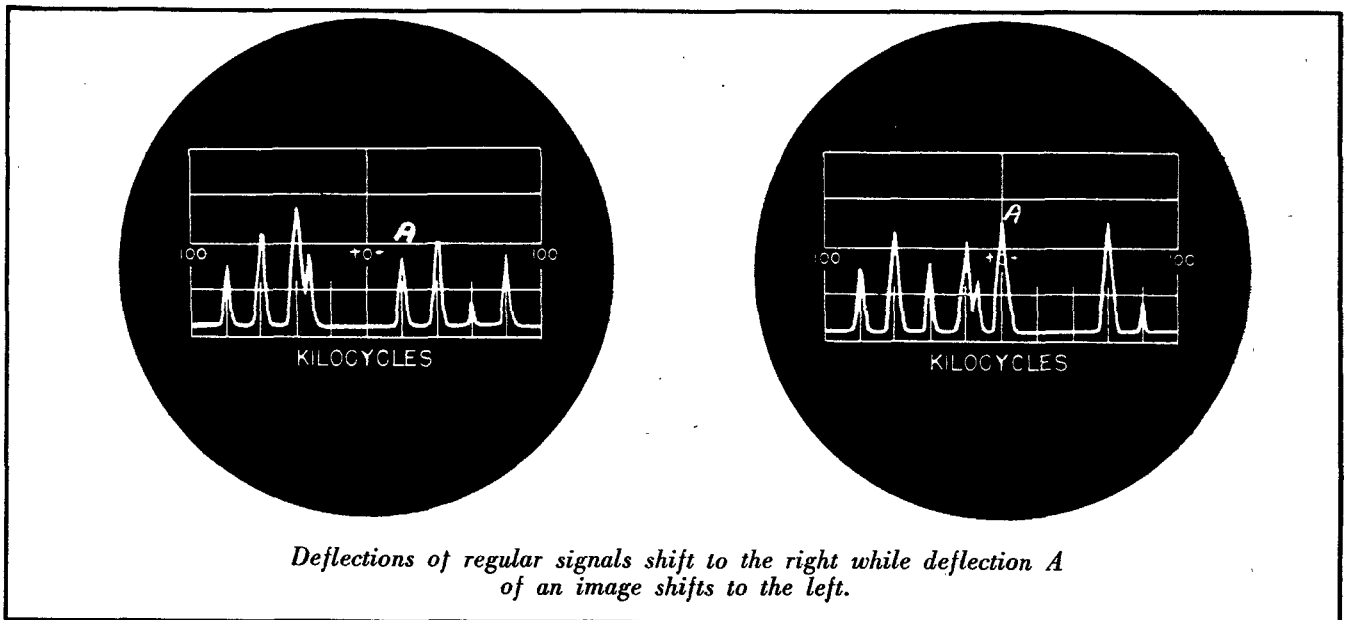

**Figure 12. Direction of Travel of Images Against Regular Signals as Receiver is Tuned**

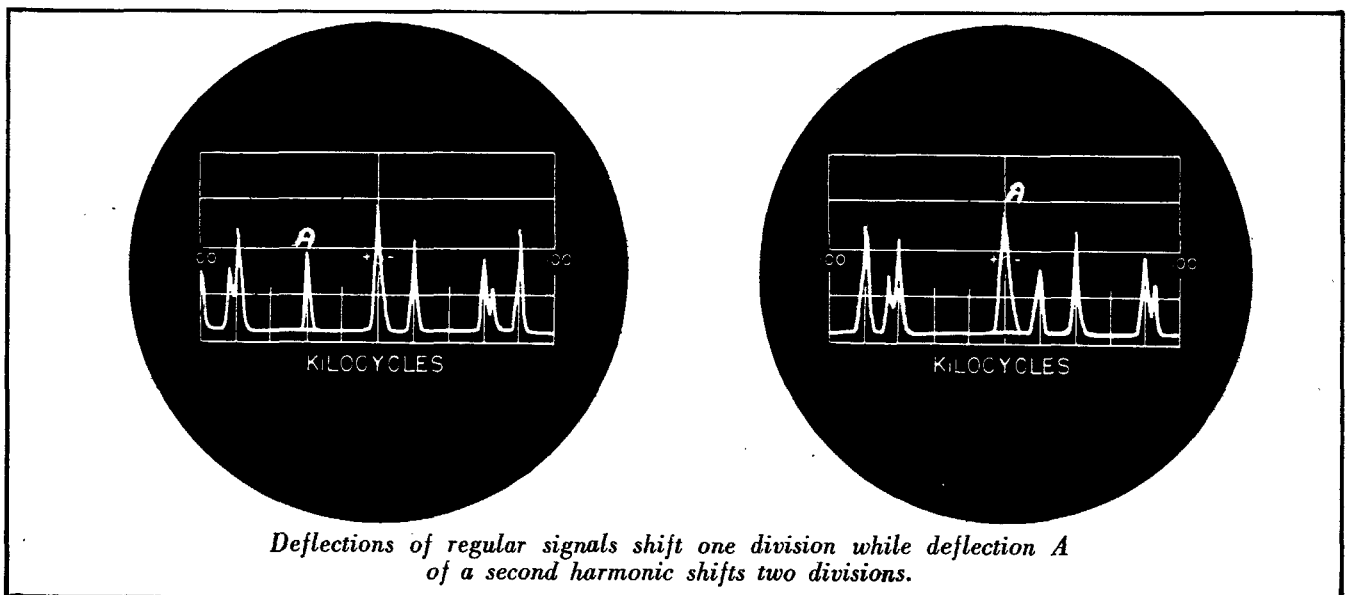

**Figure 13. Behavior of Deflections of Harmonics Compared With Deflections of Regular Signals as Receiver is Tuned**

(13) *Harmonics* produced in the receiver by the beat of very strong signals with harmonics of the oscillator, will be distinguishable from other signals by the fact that they move on the screen more rapidly (with tuning) than the normal signals. (Twice as fast for second harmonic spurious signals). Generally, a reduction in the gain of the receiver will eliminate this type of spurious signal. Refer to Figure 13.

(14) *Diathermy apparatus* using an unfiltered or A.C. power supply will produce a periodic dis-

turbance which will cause a deflection to appear on certain portions of the screen and disappear on other portions as the receiver is tuned. This is due to the fact that such equipment emits a signal pulsating in synchronism with the power line.

On the other hand, the PANADAPTOR, too, is sweeping the spectrum in synchronism with one half the line frequency. Only when a certain phase relationship exists does the PANADAPTOR display those periodic pulses.

## 2. AUDIBLE PANORAMIC.

Plug a pair of crystal phones or an audio-amplifier into the audio output jack at the rear of the PCA-2 chassis. Adjust the equipment for Visible Panoramic.

Tune the receiver to the center of the 200KC portion of the band to be monitored.

The appearance of a signal is indicated by a 30 cycle buzz in the audio channel of the PANADAPTOR.

The location of the signal in the band is shown on the Panoramic screen and the signal can be tuned in quickly by turning the receiver tuning dial so that the signal moves to the center of the screen.

As the number of signals entering the band increases, the pitch of the buzz rises. The loudness of the buzz is controlled by the GAIN Control and SWEEPWIDTH setting. When the SWEEPWIDTH is a zero, the buzz disappears.

For aural observation of less than 200KC of the band the following procedure can be used. The receiver is tuned to any crowded band. Any deflection is selected, on the (+) or (—) side of the screen, which is higher or lower than the signal heard through the receiver by one half of the bandwidth to be observed. (Example—If it is desired to observe 120KC of the band, any deflection 60KC from the center mark is selected). The SWEEPWIDTH Control is rotated counter-clockwise until the selected deflection just runs off the screen. The receiver is then tuned to the center of the portion of the band to be observed.

## 3. VISIBLE SINGLE-SIGNAL.

Adjust the equipment for Visible Panoramic operation. For visual observation of the signal heard through the receiver, slowly reduce the SWEEPWIDTH to zero and maintain the deflection at center. When the SWEEPWIDTH Control is at zero, obtain maximum deflection by slight adjustment of either the CENTER FREQ. Control or the receiver tuning knob.

For examination of modulated signals, it is best to adjust the PANADAPTOR GAIN Control so that when no modulation is present the straight horizontal trace coincides with the center horizontal line on the screen.

For visual examination of any one signal on either side of the screen, without affecting reception of the signal heard through the receiver, the following procedure can be used. With the PANADAPTOR set for Visible Panoramic, The CENTER FREQ. Control is rotated so that the signal to be examined is directly over the zero mark. The SWEEPWIDTH is reduced to zero and the CENTER FREQ. Control is trimmed for maximum upward deflection of the signal trace.

### IMPORTANT

The CENTER FREQ. knob is factory set for proper zero position. The extreme clockwise and counter-clockwise positions may not coincide with the maximum calibration marks. The calibration marks are not given in terms of frequency.

Signals will appear in the following manner during this type of operation.

*Constant Carrier.* The baseline is elevated above its normal position.

*An Amplitude Modulated Carrier.* The modulating waveform shows on the screen.

*CW Signal.* The baseline rises and falls in step with the transmitter keying.

*MCW Signal.* The baseline is elevated above its normal position and as the transmitter is keyed, the tone modulation appears and disappears in step with the keying.

*Synchronous Noise.* The baseline is broken up into "grass" deflections. *Clear areas may be present.*

## 4. AUDIBLE SINGLE-SIGNAL.

This type of operation is used for listening simultaneously to a station heard through the receiver and to a second signal up to 100KC on either side of this station.

With the phones or audio amplifier plugged into the PANADAPTOR, adjust the equipment for Visible Panoramic. Tune the receiver to any desired signal. Tune the PANADAPTOR to the second signal by first centering its deflection on the screen with the CENTER FREQ. Control. Gradually turn the SWEEPWIDTH Control to zero at the same time keeping the deflection at center, should it shift sidewise. Trim the CENTER FREQ. Control for maximum volume and thereafter use the PANADAPTOR GAIN Control to obtain the desired audio

output level. Keep the GAIN low. Strong signals may be cut off if the GAIN is advanced too far.

Other stations may be tuned in on the PANADAPTOR, one at a time, simply by turning the CENTER FREQ. Control while turning the CENTER FREQ. Control while the SWEEPWIDTH is set at zero. However, to tune in signals of known frequency, it is best to restore the deflection of a signal whose frequency is known with respect to the station heard through the receiver. The same procedure, described in the paragraph above, is used to tune in this signal through PANADAPTOR.

### APPLICATIONS of the PANADAPTOR

The applications of the PANADAPTOR are by no means limited to the techniques suggested below. Undoubtedly, in time, the operator will discover many new ingenious uses for the PANADAPTOR, which will promote the ever-growing art of Panoramic Reception. The Panoramic Radio Corporation will appreciate receiving information on new applications which may then be distributed to other users of the PANADAPTOR.

#### 5. RECEPTION WITH THE PANADAPTOR (PANORAMIC METHOD).

The PANADAPTOR is adjusted for Visible Panoramic.

*a. TUNING THROUGH THE BAND.* The band can be viewed by watching any desired section (up to 200KC). The deflections of stations of interest may be identified through their relative heights, behavior, and location with respect to other signals.

A station is tuned in simply by rotating the receiver tuning knob so that the "pip" corresponding to the station is shifted to the center of the screen and the station is heard.

Tuning with the Panoramic screen prevents overlooking stations due to momentary absence of the signal, too rapid tuning, or intermittent noise since the signals may be seen at least forty times longer by the eyes than they are heard by the ears. Receiver tuning is speeded up by the elimination of eye strain and loss of time required in reading receiver tuning dial calibrations.

*b. TUNING SIGNALS COVERED BY SYNCHRONOUS NOISE.* Signals which normally cannot be heard because of synchronous noise interference may be seen on the Panoramic screen.

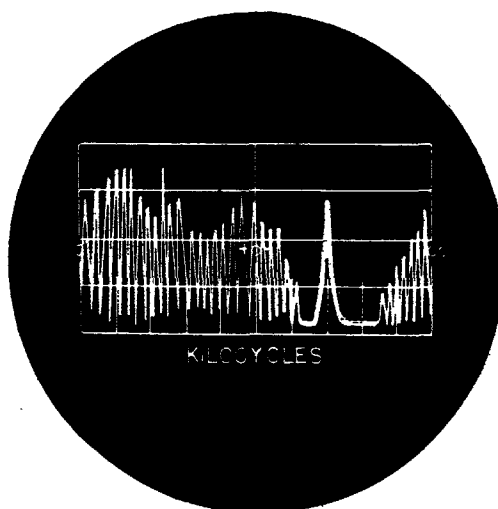

**Figure 14. Visual Appearance of a Signal Through Synchronous Noise**

When the appearance of such noise washes out reception of a signal, it may be futile to try to hear it; but the receiver may be tuned so that the signal is seen along a possible clear spot on the baseline. Several things may be done.

The transmitting end may be advised that its signal is seen but not heard and that further transmission be delayed until the noise disappears.

If the signal is in code, the transmitting end may be requested to send sufficiently slow so that the code characters can be read off the screen.

The operator can keep watching the signal "pip" until the noise stops and then retune the receiver to the station.

#### 6. AUTOMATIC VISUAL MONITORING.

While listening to a station or transmitting, attention should be focused on the screen of the PANADAPTOR, which has been set for Visible Panoramic.

As an unidentified new signal appears on the screen, it may be heard through the PANADAPTOR by employing the procedure for Audible Single-Signal operation. If it is desired to work the new station through the companion receiver, the receiver is tuned in the direction of the station until the audio output of the receiver and PANADAPTOR match.

## 7. AUTOMATIC AURAL MONITORING.

The PANADAPTOR is adjusted for Audible Panoramic operation of any particular bandwidth. The receiver is tuned to the center of the portion of the band to be monitored.

When a clear buzz is heard through the audio output of the PANADAPTOR, the Panoramic screen is checked for the signal deflection and the station is tuned in on the receiver by the Panoramic method.

This application allows monitoring of a band of frequencies up to 200KC wide without the necessity of the operator being present at the receiver.

## 8. THREE-WAY QSOs.

The PANADAPTOR is adjusted for Visible Panoramic Operation. The receiver is tuned to one of the stations in the three-way group, and its "pip" is identified. The receiver is tuned to the other station while the shifting identified "pip" of the first station is kept under observation.

The first station is tuned through the audio output of the PANADAPTOR by using audible single-signal operation.

In this way the PANADAPTOR acts as an additional tunable receiver and the three-way QSO is possible without tuning the receiver back and forth.

It is also relatively simple to maintain a three-way QSO by adjusting the PANADAPTOR for *Visible Panoramic Operation* and tuning back and forth, from one corner of the QSO to the other, *by the Panoramic Method*. This will allow detection on the Panoramic screen of any other station which might wish to break in on the QSO, by coming in on, or adjacent to, the frequency of one of the stations when that operator finishes.

## 9. WATCHING FOR CQs.

The PANADAPTOR is adjusted for Visible Panoramic Operation for any desired bandwidth up to 200 KC. As the receiver is either tuned slowly through the band or kept at the center of the band under observation, watch the screen for the rhythm of a keyed CQ in a bobbing "pip." A little practice may be required to recognize a CQ. The receiver is then quickly tuned to the CQ by the *Panoramic Method*.

Obviously, if a "pip" shoots up indicating the appearance of a phone or high speed code signal, it

will be necessary to tune the receiver, by the Panoramic method, to the new station to check whether or not it is sending a CQ.

## 10. SPOTTING REPLIES TO YOUR CQs.

The PANADAPTOR is set for Visible Panoramic Operation and the Panoramic screen is observed for band activity as soon as your CQ is transmitted.

When the apparent replies to your CQ pop up on the screen, it is possible to tune in each one rapidly on the receiver set by watching the screen (Panoramic Method) and to select the reply to be answered.

In this way no replies are missed since any receivable signal shows up on the screen immediately.

## 11. NETTING OPERATIONS FOR TRAFFIC OR EMERGENCY.

a. NET REGROUPING. When QRM on a given net frequency renders successful operation impossible and the net is directed to operate on another frequency, rapid regrouping may be accomplished in the following manner:

The PANADAPTOR of the Net Control Operator is set for Visible Panoramic and he watches his screen for the appearance of net activity on the *new* frequency. The receiver is quickly tuned to this frequency by the Panoramic method.

The screen may be observed continuously to prevent missing the signal of any net operator which may be slightly off the new net operating frequency.

b. AUXILIARY NETS. While working one net, the Panoramic screen may be watched, under Visible Panoramic Operation, for a call from another auxiliary net.

With practice one's call letters can be learned in terms of the rhythm of a bobbing "pip."

The auxiliary net can be tuned in through the audio output of the PANADAPTOR by switching to Audible Single-Signal Operation. By this procedure it is possible to receive both nets simultaneously until it is decided which net will be worked.

c. NET IN WHICH EACH STATION IS ON A DIFFERENT FREQUENCY. The PANADAPTOR is adjusted for Visible Panoramic and the receiver may be tuned to either the mean operating frequency of the net or to the net control station. The screen is watched for the presence, absence, and behavior of each net member.

As a net station appears on the screen, the receiver is tuned to the station by the Panoramic Method. The screen is continuously observed for possible break-in operation by another member of the net.

The Panoramic picture will tie the net together tightly by eliminating missed calls, break-ins, and off-frequency stations by expediting rapid-fire tuning of the receiver.

## 12. SELECTING QRM FREE SPOTS.

*a.* CHOOSING A CLEAR SPOT FOR LISTENING. During a QSO, the PANADAPTOR is operated for Visible Panoramic. When QRM begins to cut into reception, a clear area may be found on the screen and its frequency determined from the calibration on the screen.

The transmitting end may then be advised where and how much to shift the transmitter frequency. The screen is watched for the appearance of the signal in this area and the receiver is tuned to it by the Panoramic Method.

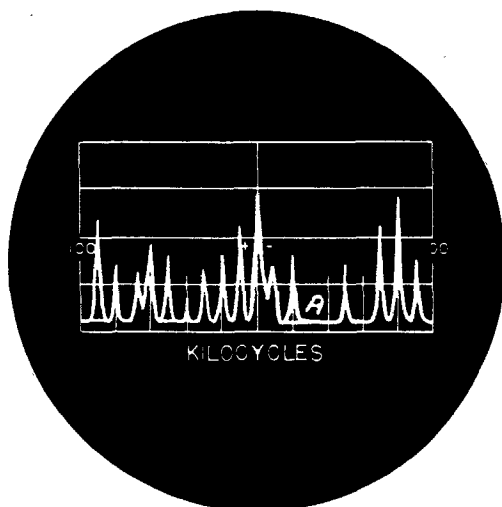

(A) QRM—Free Area

**Figure 15. Location of a QRM—Free Spot**

If the transmitting end shifts frequency close to a station at the fringe of the clear area, the two signals will heterodyne and this will be evidenced by a bobbing deflection. It may become necessary to reduce the SWEEPWIDTH to reveal on which side the heterodyne modulation takes place. By "breaking in," the transmitting end may be advised the direction and magnitude of frequency shift still necessary for clear operation.

*b.* CHOOSING A CLEAR SPOT FOR TRANSMITTING.—By operating the PANADAPTOR on Visible Panoramic it is possible to observe the screen for a clear spot and to determine its frequency. The transmitter can be adjusted for operation on this frequency. If your transmitted signal is QRMed at the remote receiving point, that operator might refer to his PANADAPTOR and advise where and how much to shift frequency for a clear QSO.

## 13. LOCATING STATIONS WHOSE EXACT FREQUENCIES ARE UNKNOWN.

When a transmission is scheduled to appear within a definite portion of a band (e.g., high end, middle, or low end), the receiver may be tuned to the center of the particular portion of the band, before the schedule time, and the PANADAPTOR set for Visible Panoramic.

As each new signal appears on the screen, it can be tuned in quickly on the receiver. At the same time, the Panoramic screen is watched for the appearance of new "pips" until the scheduled signal is located.

This is also ideal for DX work when you are watching several DX stations for a possible opportunity to call them.

If the receiver is turned on during the scheduled time for transmission, the signal may be located by tuning the receiver from station to station ("pip to pip"). While tuning, it may be of help to become familiar with the pattern of a group of stations so as to detect the appearance of a new "pip" within the group. This "pip" might represent the scheduled transmission.

## 14. INSTANTANEOUS SIGNAL STRENGTH ("S") METER FOR PHONE AND CW.

Before "S" readings can be taken from the Panoramic screen, it is necessary to calibrate the screen. This is relatively simple.

The R.F. Gain Control of the receiver is set to maximum and the AVC is switched off just as for the usual "S" measurements. The PANADAPTOR is set for Visible Panoramic.

An S9 phone or constant carrier signal is tuned in on the receiver and the PANADAPTOR GAIN control is adjusted for maximum center deflection.

The GAIN control should not be advanced too far or the top of the "pip" will flatten along the upper signal limit line. This feature has been incorporated to prevent signals from running off the top

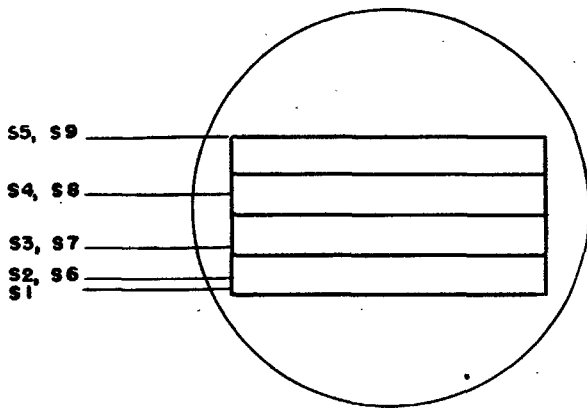

**Figure 16. Calibration of Panoramic Screen for Instantaneous "S" Readings**

of the screen. The stronger the signal is, the broader the deflection will be.

This position of the PANADAPTOR GAIN control should be noted for "S" readings between S9 and S6.

Signals from S9 through S6 are tuned in succes-

sively. The height of each corresponding "pip" is noted and the screen is calibrated accordingly.

An S5 signal is then tuned in and the PANADAPTOR GAIN control is *reset* for maximum center deflection. This setting is noted for "S" readings between S5 and S1. Signals from S5 to S1 are tuned in and the screen is calibrated for each of these signal strengths.

**Note**

The S5 to S1 calibrations will be almost identical to those for S9 to S6 signals. The calibrations are valid for only those signals appearing at the center of the screen.

An alternate method of taking "S" readings consists of calibrating the PANADAPTOR GAIN control *only* to produce one given deflection height for signal strengths ranging from S1 to S9.

The *receiver* R.F. gain is set at maximum and the AVC is switched off. An S9 signal is tuned in and the GAIN control of the PANADAPTOR is adjusted until the signal height reaches the first horizontal division. This GAIN control setting is noted.

In a like manner the GAIN control is calibrated for all "S" readings either by substituting a signal generator for the S9 signal and reducing the gen-

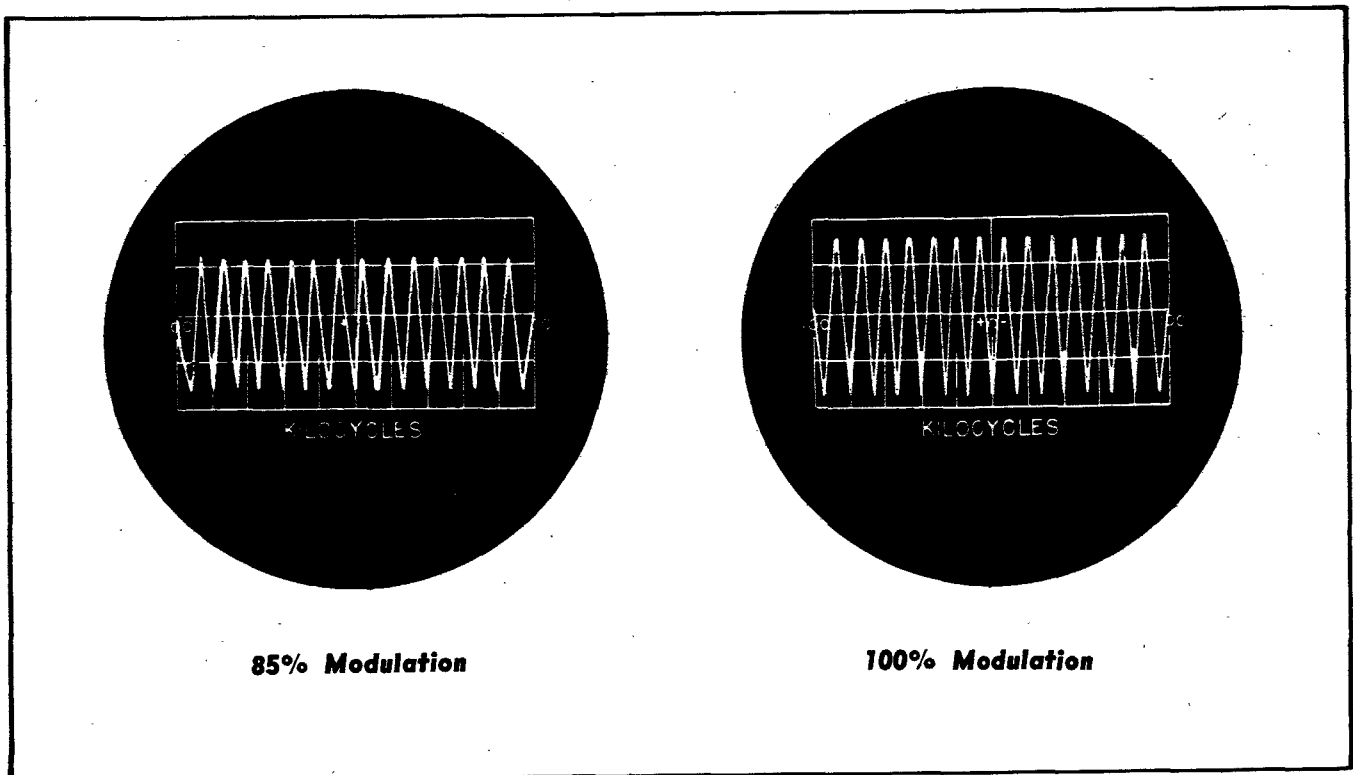

**Figure 17. Calibration of Panoramic Screen for Percentage of Modulation**

erator output voltage by 6 db ( $\frac{1}{2}$ ) for each "S" step or by tuning in signals from S9 to S1.

#### IMPORTANT

Either type of calibration, knob or screen, is applicable *only* to the station heard through the receiver.

### 15. MEASURING PERCENTAGE MODULATION (AM).

#### OPERATING HINT

When the PANADAPTOR is used at the transmitting end to examine the output of the transmitter, it may be of help to remove the antenna from the receiver or substitute it with a short length of wire, or even "short" the antenna and ground posts. The transmitter power may be reduced to prevent overloading of the receiver.

Before measurement can be made, it is necessary to calibrate the Panoramic screen, in terms of percent of modulation, against a source of amplitude modulated R.F. in which the modulation percentage can be determined. A good signal generator with a reliable modulation meter or *any station either local or distant* with facilities for measuring percentage of modulation of its carrier will do.

The PANADAPTOR is first set for Visible Panoramic and the receiver is tuned to a signal, modulated by a frequency under 500 cycles per second, from either of the above sources and then operation is switched to Visible Single-Signal. The CENTER FREQ. Control or the receiving tuning dial is trimmed for maximum deflection. The baseline is elevated by the GAIN Control so that it coincides with the center horizontal line on the screen. It may be necessary to remove modulation to facilitate this adjustment.

Beginning with zero modulation, the modulation percentage is increased in steps of 20% or any other desired percentage. The height of the modulating waveform on the Panoramic screen is noted for each step and the screen is calibrated. The upper half of the modulation is limited by pulse AGC and will appear somewhat shorter than the lower half. This is illustrated in Figure 17.

#### IMPORTANT

These calibrations are exactly applicable only when the modulation frequency is approximately 500 cycles per second or less.

Because of the high selectivity of the PANADAPTOR IFs and the time constant of the diode load filter, sidebands *more* than

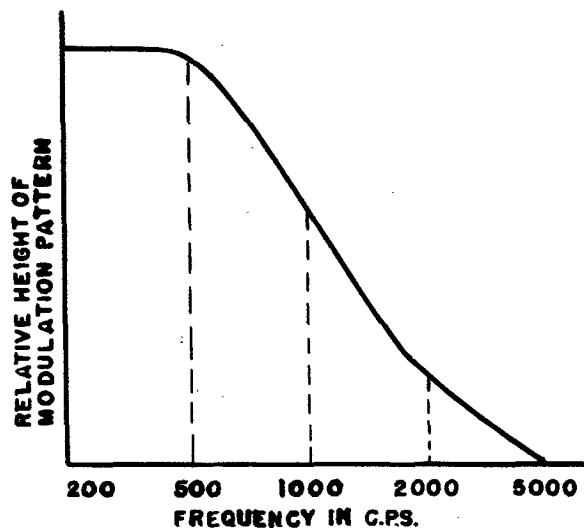

Figure 18. Variation of Height of Modulation Pattern Against Modulating Frequency

500 c.p.s. from the carrier are attenuated and the corresponding waveform height on the Panoramic screen is reduced accordingly.

The graph in Figure 18 shows a typical variation of waveform height (or calibration) against modulation frequency at 100% modulation.

*Overmodulation is indicated by flattening or clipping of the lower peaks of the modulating waveform along the baseline. (See splatter).*

### 16. SPOTTING DISTORTION (AM SIGNALS).

The receiver is tuned accurately to the signal to be examined and the PANADAPTOR is set for Visible Single-Signal reception of the signal in question.

Distortion of the signal due to overmodulation is indicated on the Panoramic screen by clipping of the lower peaks of the modulating voltage along the baseline. If the overmodulation is quite high, the upper peaks may appear clipped.

Distortion of the signal due to poor modulator characteristics or a mismatch of the modulator and the R.F. section may also be indicated on the screen by clipping of peaks.

Distortion may be spotted also by operating the PANADAPTOR on Visible Panoramic at reduced Sweepwidth. Spurious signals which are a product of distortion may appear along the baseline or at the sides of the signal deflection.

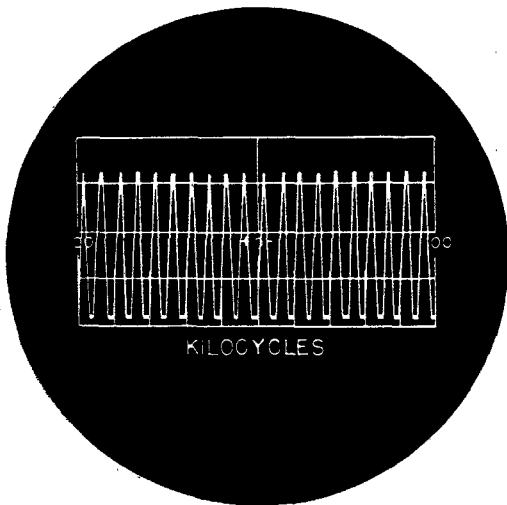

**Figure 19. Distortion of a Tone Modulated Signal Due to Overmodulation, Peaks are Clipped at Baseline**

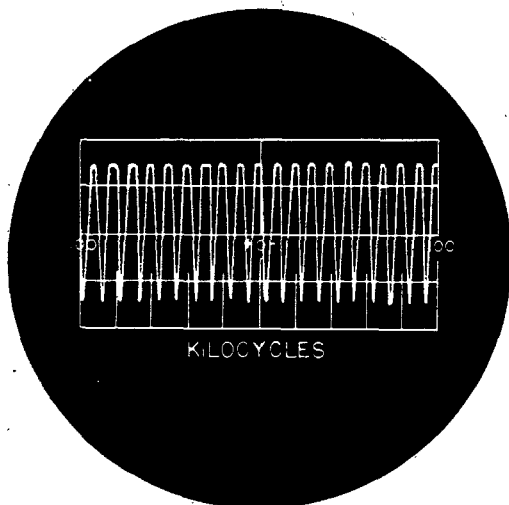

*Clipped upper peaks indicating distorted sine wave.*

**Figure 20. Distortion of Tone Modulated Signal Due to Poor Modulation Characteristics**

### 17. SPOTTING SPURIOUS SUPERSONICS AND R.F. PARASITICS.

A transmitter may be modulated by spurious supersonics which interfere with adjacent signals. Audio detection of the offending transmitter is generally impossible. At times the supersonics are so

strong that when added to normal audio modulation, overmodulation with resultant interference arises.

The presence of R.F. parasitics in a transmitter will drastically reduce the effective output of the transmitter and will also introduce QRM which is difficult to track down without a PANADAPTOR.

The presence of parasitics and supersonics on a received or transmitted signal can be detected on the Panoramic screen by the following suggested procedure: The receiver is tuned to the signal under investigation with the PANADAPTOR adjusted for Visible Panoramic and the GAIN Control turned up as high as possible without introducing spurious signals. The screen is carefully examined as the station goes on and off the air.

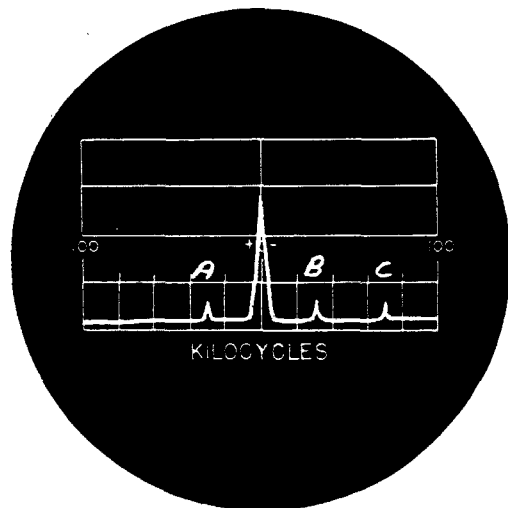

*A and B—Sidebands due to 30KC supersonics.  
C—Parastic 70KC below Carrier.*

**Figure 21. Typical Pattern of a Signal Modulated by a Supersonic, Parasitic at a Lower Frequency than Carrier**

The presence of supersonics or R.F. parasitics is indicated by the appearance and disappearance of small scattered "pips" in step with the signal deflection as the transmitter is turned on and off.

Possible overmodulation because of supersonics is indicated by the appearance of small random "pips" along the baseline as the carrier is audio modulated.



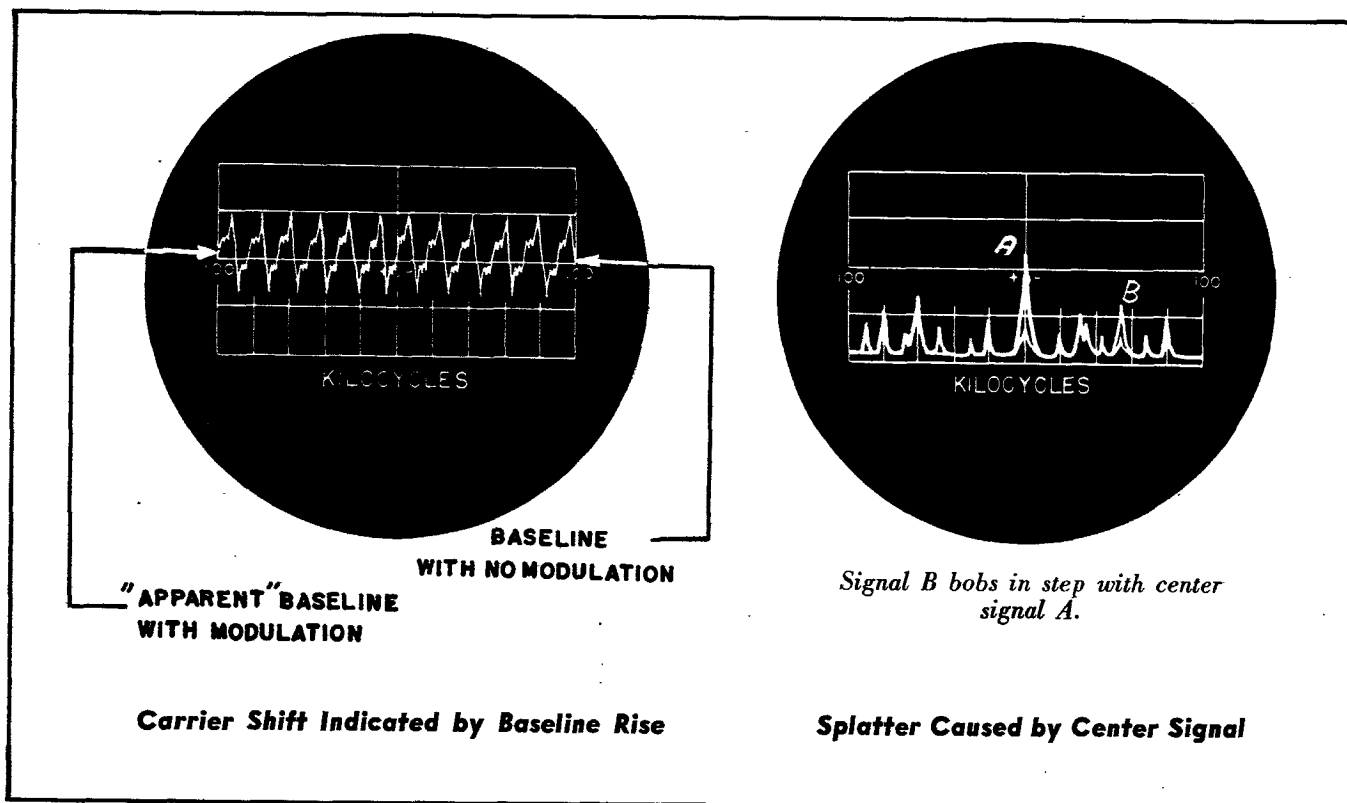

Figure 22. Carrier Shift and Splatter.

### 18. DETECTING SPLATTER AND CARRIER SHIFT.

The receiver is tuned, with the PANADAPTOR set to Visible Panoramic, to the station to be examined. The screen is observed for the presence of one or more "pips" that bob up and down exactly in step with the deflection of the tuned in signal as it is modulated. Such "pips" reveal splatter. At times it may be noted that the splatter causes interference with a "pip" of another signal and this "pip" will rise and fall with the modulation.

It is also possible to recognize carrier shift by examining the signal through Visible Single-Signal Operation. This will be indicated by the rise and fall of the "apparent" zero line through the modulating waveform voltage as the signal is modulated.

### 19. DETECTING FREQUENCY DRIFT.

The PANADAPTOR is adjusted for Visible Panoramic.

Frequency shift of a carrier is noticeable on the Panoramic screen by the sidewise movement of a signal deflection while all other deflections, exclusive of FM signals, remain in a constant position along the horizontal axis. The direction and magnitude

of the shift is readily determined from the screen calibrations.

Small degrees of frequency shift can be detected with increased ease by operating with Visible Panoramic at reduced Sweepwidth. This is ideal for monitoring a station for frequency stability.

### 20. INVESTIGATING CW SIGNALS FOR KEY CLICKS.

A clean CW signal will appear under Visible Single-Signal Operation as a clean horizontal trace which rises and falls in step with the keyed characters. If the trace shows "grassy" deflections rising and falling as the key is closed and opened, key clicks or spurious signals are being transmitted.

Key clicks will also be obvious when operating the PANADAPTOR on Visible Panoramic at reduced Sweepwidth. The broad CW deflection will show merging pips along either one or both of its sides. These irregularities may be more pronounced at the base of the deflection.

### 21. CHECKING AND ADJUSTING FREQUENCY DEVIATION OF FM SIGNALS.

It is possible to check and monitor the frequency deviation of an FM signal instantaneously at the

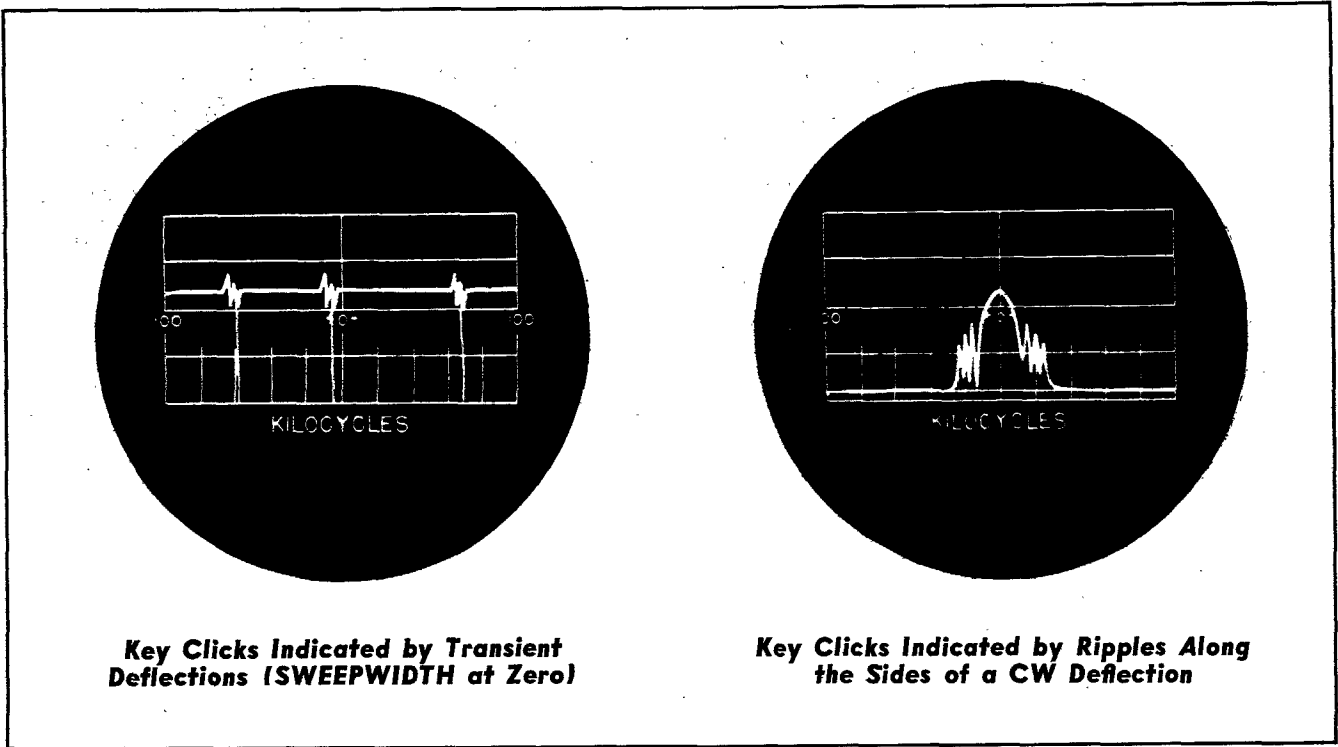

**Figure 23. Patterns of Key Clicks**

receiving or transmitting end, by observing it on the Panoramic screen.

For voice or music FM signals, the extent of frequency deviation (and therefore audio level) varies continuously whereas for a tone FM signal of uniform strength, the deviation is constant. For either case, *the extent of deviation is instantly shown by the limits of the horizontal spread of "pips" across the screen.*

The *bandwidth of the signal* is equal to the sum of the frequency deviation to the right and left of the center zero mark on the screen.

The *signal energy distribution* of the signal through the frequency spectrum is shown by the envelope of the "pips."

To check frequency deviations within narrow limits such as  $\pm 15\text{KC}$ , the SWEEPWIDTH control is adjusted to give a *maximum visual display* of 50KC (Refer to the procedure for Audible Panoramic). At this setting each calibration mark on the screen equals 5KC.

It is important that the GAIN be sufficiently high so that the sideband "pips" at the ends of the spread are shown. An instantaneous frequency deviation of  $\pm 15\text{KC}$  from the center frequency is shown in Figure 24.

It will be noted that "pips" which are approximately 4KC apart tend to merge below their waists. This is normal and the energy distribution is still shown by the envelope of the pattern.

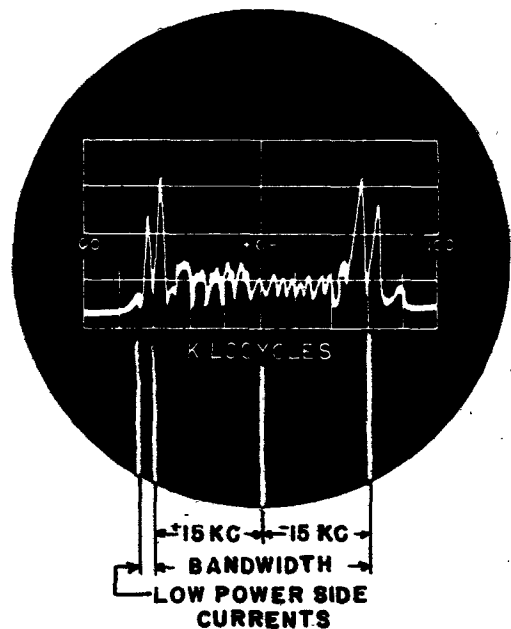

**Figure 24. Instantaneous Display of Frequency Deviation of  $\pm 15\text{KC}$  (SWEEPWIDTH set for 50KC)**

If a broadcast FM station is monitored for a 150KC maximum bandwidth, the SWEEPWIDTH control should be at maximum. The appearance of modulation "pips" outside the 75KC limits on either side of the zero mark on the screen indicates "over-modulation."

To adjust the upper limit of modulation of an FM transmitter, it is advisable to use a constant tone modulating voltage from an A.F. tone oscillator. A tone frequency of 15 KC is suggested for broadcast FM.

It will be noted when a 15KC audio is used and the audio gain control of the modulator is advanced up from zero, the height of the carrier deflection, on the screen, will gradually fall and "pips" will appear and rise 15KC on either side of center.

As the modulation is increased, two new "pips" will appear 30KC on either side of zero. As they rise, the carrier will fall to zero level (disappear) when the frequency deviation is 2.4 times greater than the audio modulating frequency.

Further increases of modulation result in appearance of new "pips" 45KC, 60KC, 75KC, etc., on either side of the center; and in passing through given deviation ratios the carrier and "pips" successively fall to zero and then rise.

#### Note

The carrier successively goes to zero when the deviation ratios are 2.4, 5.52, 8.65, 11.8, etc. The ratio of deviation,  $M_p = \frac{\text{freq. deviation}}{\text{audio freq.}}$

To adjust the transmitter for a frequency deviation of 75KC, with a modulation frequency of 15KC, the Audio Gain Control is set to produce a pattern similar to one illustrated in Figure 25.

A practical and accurate means of obtaining a particular frequency deviation is to set the A.F. tone oscillator for a frequency equal to the particular frequency deviation desired divided by a deviation ratio for zero carrier level, and advance the Audio Gain Control until the carrier deflection goes to zero the proper number of times. *Example:* For a deviation of 60KC, the audio oscillator is set at  $60/2.4=25$ KC and the Audio Gain Control (modulator) is adjusted until the carrier deflection dips to zero once.

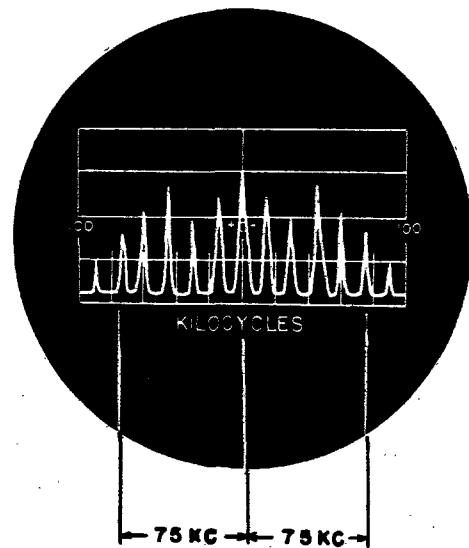

Figure 25. Frequency Deviation of  $\pm 75$ KC at a Modulation Frequency of 15KC

For  $60/5.52 = 10.87$ KC, the Gain Control is advanced so that the carrier dips to zero twice.

## 22. IDENTIFYING AM ON FM SIGNALS.

Normally, signals which are frequency modulated by a *sine wave* consist of vertical deflections equally disposed on both sides of the carrier. The pattern of the envelope over the deflections is symmetrical on either side of the carrier.

The presence of AM on FM is indicated by a twist in the envelope pattern. The envelope on one side of the carrier deflection will appear shifted up with respect to the envelope pattern on the other side.

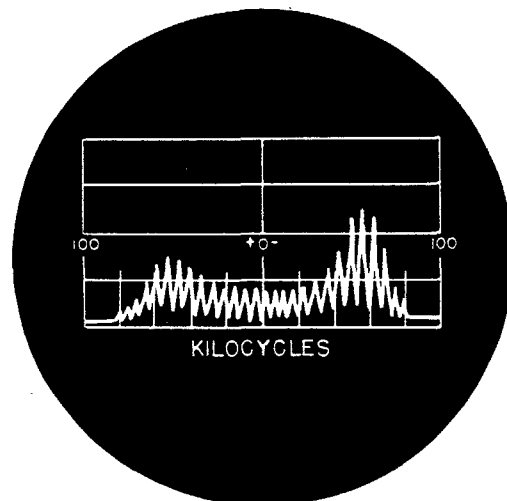
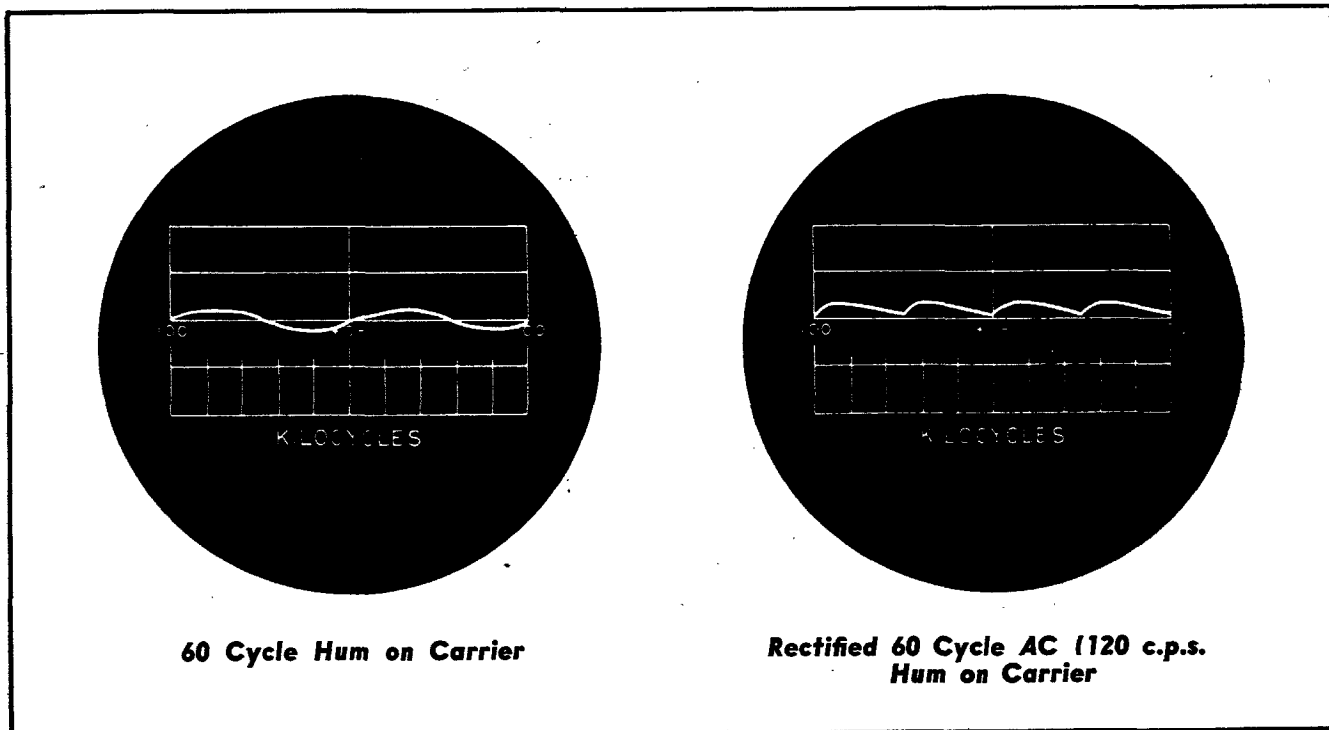

Figure 26. Presence of AM on FM Indicated by a Non-Symmetrical Envelope Pattern



**Figure 27. Hum on Carrier**

In examining a received or transmitted signal, the PANADAPTOR is operated on Visible Panoramic. It is preferable that the station be modulated by a steady sine wave so that a stationary pattern of deflections is obtained.

### 23. DETECTING RESIDUAL HUM ON A CARRIER.

The carrier to be examined is tuned in to the center of the Panoramic screen and the PANADAPTOR is adjusted for Visible Single-Signal. If the elevated baseline is curved or hooked it indicates hum on the carrier. Another carrier may be tuned in and its baseline can be compared with the former to determine the relative hum content.

If the hum is FM hum, the phase of the hum on the baseline is reversed as the CENTER FREQ. Control is passed through its zero position or if the receiver is tuned through the station slowly. But if the hum is AM hum, this phase reversal does not occur.

### 24. FREQUENCY SETTING AND MEASURING.

The PANADAPTOR facilitates high speed frequency setting of a transmitter by *showing* reference markers of a frequency standard, and simultaneously acting as a frequency "ruler" for determining both the marker frequency and the transmitter frequency with respect to the marker frequency.

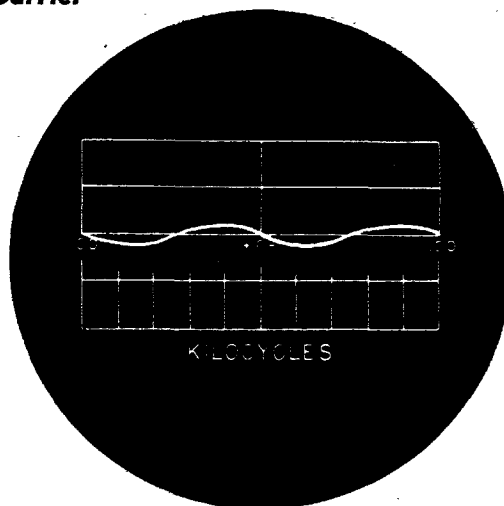
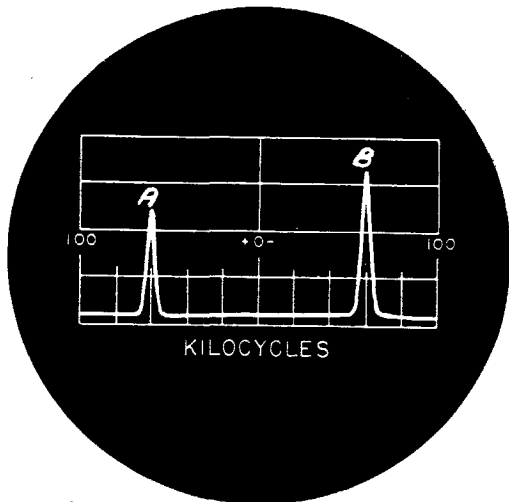

**Figure 28. F.M. Hum on Carrier Indicated by Phase Reversal of Hum Pattern as the Receiver or CENTER FREQ. Control is Tuned Through a Station. (See Figure 27).**

*a.* CRYSTAL STANDARD. — If a crystal standard is available, it is possible to set the transmitter on any frequency within  $\pm 100\text{KC}$  of the standard frequency.

With the PANADAPTOR set for Visible Panoramic at maximum SWEEPWIDTH, the receiver is tuned to the standard. If the transmitter frequency is to be set *above* the standard frequency, the receiver is retuned so that deflection for the

standard signal appears over a calibration at the extreme *right* or (—) side of the screen. (The deflection is shifted to the left or (+) side for frequency setting *below* the standard frequency).



*A*—Crystal standard of known frequency.  
*B*—Transmitter 120KC below crystal standard.

**Figure 29. Frequency Setting with a Crystal Standard**

Using the screen calibrations as a frequency “ruler,” the transmitter frequency is set so that its deflection appears the desired number of kilocycles to the left of the standard pip. (For setting the frequency *below* the standard, the transmitter “pip” should appear to the *right* of the standard “pip” by the desired number of kilocycles.)

The linearity of the PANADAPTOR enables the transmitter to be placed within  $\pm 2.5$  KC of the desired frequency.

*b.* SECONDARY STANDARD. — A 50KC or 100KC secondary standard may be used. The receiver is tuned to within  $\pm 100$ KC of the frequency on which the transmitter is to operate and the PANADAPTOR is set for Visible Panoramic.

Reference marker “pips” (50KC or 100KC) will appear on the screen and their frequency can be determined from the receiver tuning dial setting.

The transmitter frequency is set so that its deflection appears at the desired number of KC above or below a selected marker whose frequency has been determined, the screen calibrations being used as a frequency “ruler.”

**Example**

Transmitter to be set on 28.665mc.. Using 50KC secondary standard, the receiver is

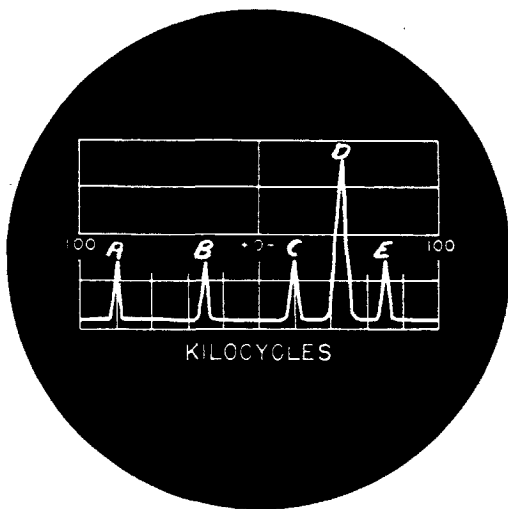

*A - B - C - E*—50KC markers.  
*C*—Lower 50KC calibration of receiver tuning dial.  
*D*—Transmitter 25KC below marker *C*.

**Frequency Setting With a Secondary Standard**

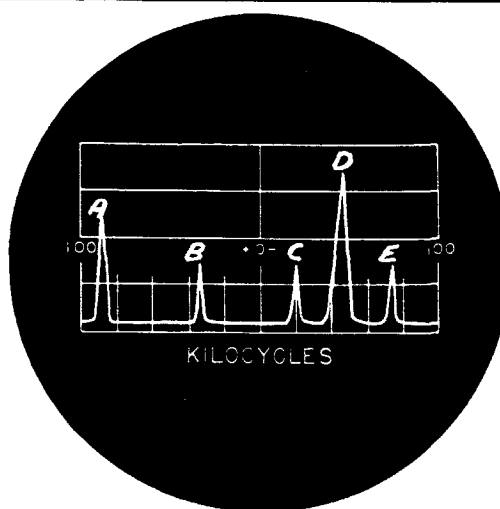

*A*—Secondary standard marker.  
*B - C - E*—10KC multivibrator markers.  
*C*—Lower 10KC calibration of receiver tuning dial.  
*D*—Transmitter 5KC below marker *C*.

**Frequency Setting With a Secondary Standard and 10KC Multivibrator (at Reduced Sweepwidth)**

**Figure 30. Frequency Setting with Secondary Standards**

tuned to approximately 28.660KC. A 50KC marker for 28.650mc appears approximately  $\frac{1}{2}$  division to the right of the zero mark on the screen. The transmitter is then set 15KC above the marker or  $\frac{3}{4}$  division to the left of the marker.

For greater accuracy a 10KC multivibrator can

be used in conjunction with the standard. 10KC markers will be presented on the screen.

The Sweepwidth can be reduced for greater spread of the marker "pips" and thus the 10KC divisions can be broken down into fractions with increased ease. Refer to Figure 30.

## SECTION IV CIRCUIT DETAILS

The aural receiver used with the PCA-2 must be a superheterodyne having an I.F. between 450KC and 470KC. It is preferable that the receiver have at least one R.F. stage for adequate image rejection.

The circuit of the PANADAPTOR, Model PCA-2, is basically a superheterodyne in which the R.F. section is fixed tuned to 455 KC and the local oscillator is tunable, through 200KC, either manually or by frequency modulation at a definite rate.

### 1. R.F. SECTION.

The input is connected through the isolating resistor, R1, to the plate of the converter tube in the

receiver. In the plate circuit of the converter there may be many signals on either side of the I.F. due to the relatively poor selectivity of the receiver pre-selector.

The R.F. bandpass transformers, T1-12 and T2-12, of the PANADAPTOR are peaked on both sides of the receiver I.F. so that a relatively flat overall response of 200KC is obtained. See figure 31.

The peaking of T2-12 is controlled partially by the EQUALIZER control, R6. As more of the resistance of R6 is thrown into the secondary circuit, the double peaks of T2-12 become less pronounced

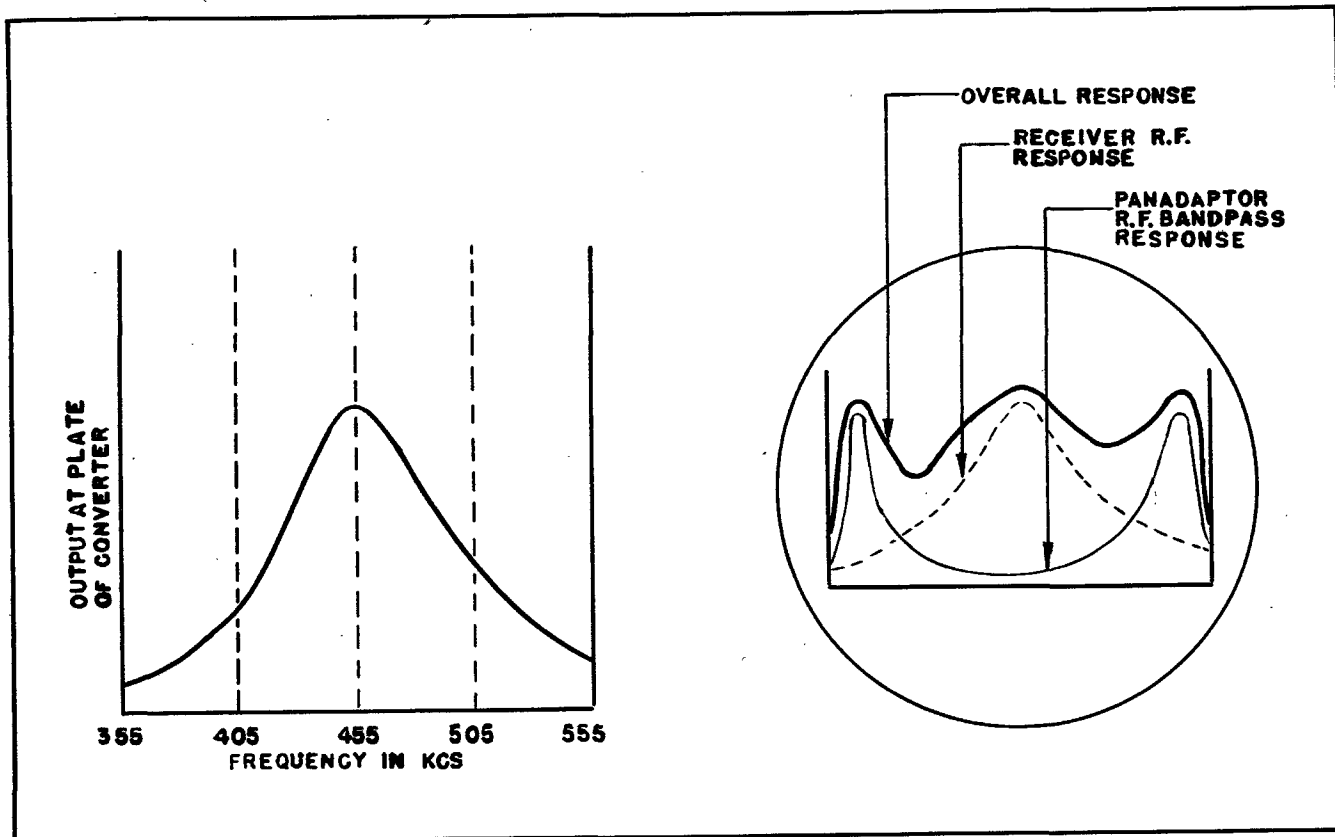
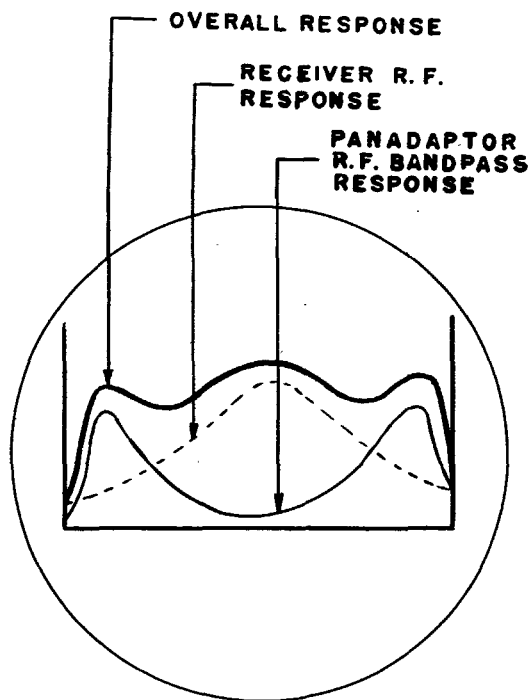

Figure 31. Overall Response of PANADAPTOR and Receiver

and, therefore, the R.F. section of the PANADAPTOR compensates less for the preselector selectivity. This is desirable when the receiver front end offers low selectivity either through design or high-frequency operation. See Figure 32.



**Figure 32. Overall Response at Reduced Pre-selector Selectivity and EQUALIZER Set for Minimum Equalization**

The R.F. section is a straight bandpass amplifier employing a 6SG7. *Manual gain control* is provided by R3.

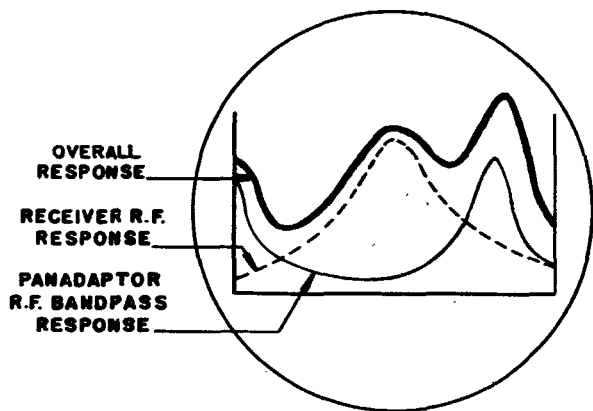

**Figure 33. Distorted Overall Response Due to Mismatch Between PANADAPTOR Mean Input Frequency and Receiver I.F.**

## 2. CONVERTER. LOCAL OSCILLATOR AND REACTOR.

The output of the R.F. bandpass amplifier, which may contain signals up to 100KC above and below the receiver I.F., is fed to the converter tube, V2, a 6SA7. The converter also receives an R.F. voltage from the local oscillator.

The *frequency* of the local oscillator is determined by the tuned circuit in Z1-12 and the reactance modulator tube, V5, which acts as a variable inductance across the tuned circuit. The magnitude of this inductance is dependent, in part, upon the transconductance of the modulator tube.

The CENTER FREQ(uecy) potentiometer, R15, controls the bias and therefore the transconductance of the modulator tube. Thus the frequency of the local oscillator can be varied within a range of up to 200KC by means of the CENTER FREQ. Control. The oscillator frequency can also be varied through adjustment of trimmer condenser C11 in Z1-12.

The oscillator mean frequency is 681KC, the sum of the PANADAPTOR I.F., 226KC, and the mean input frequency, 455KC. During Panoramic Operation the mean frequency is maintained at 681 KC by the CENTER FREQ. Control.

*During Panoramic Operation*, the oscillator is "rocked" through a band of frequencies by a linear sawtooth voltage taken off the SWEEPWIDTH control, R22, and applied to the control grid of the modulator tube. The oscillator is, thus, frequency modulated and the extent of deviation is proportional to the amplitude of the applied sawtooth voltage. The position of the SWEEPWIDTH Control contact arm determines the amount of sawtooth applied to the modulator grid.

Linear frequency calibrations on the Panoramic screen are obtained by having the oscillator frequency excursion follow the sawtooth voltage linearly. A special phase net made up of R12, R13 and C13 accomplishes this. The construction of the net is extremely critical, but once it has been properly made, it is highly stable.

As the oscillator makes its excursion it beats progressively and periodically with one incoming signal after another to produce pulses of I.F. of 226KC which are passed and amplified by the I.F. section.

*During Unisignal Operation* the contact arm of the SWEEPWIDTH Control is grounded and the modulator receives no sawtooth voltage. The CENTER

FREQ. Control then becomes a frequency or tuning control which can set the oscillator at *one* particular frequency.

### 3. I.F. AMPLIFIER.

The I.F. amplifier uses a 6SG7, V3, and is a typical stage as found in most receivers, except that its selectivity is made as high as is consistent with the sweep width and sweep rate..

### 4. DETECTOR, PULSE AGC, AND VIDEO AMPLIFIER.

The detector is the diode section of a 6SQ7, V4. Its output is directly coupled to the grid of the triode section of the same tube so that the lowest possible frequency—in this case DC—appearing across the diode load resistor will be amplified by the triode video amplifier.

During Panoramic operation, the pulses of I.F. fed to the detector appear rectified and filtered across the diode load resistor, R9. These negative voltage pulses are fed back through the filter, R7, C7, to the control grid of the I.F. amplifier. Strong signals produce high negative voltage pulses which reduce the gain of the I.F. stage. In this way the amplitude of strong signals is automatically decreased, and it becomes possible to present simultaneously signals which differ considerably in strength. The time constant of the filter is sufficiently short so that a pulse of a strong signal does not reduce the gain for an adjacent weak signal.

The output of the video amplifier is directly coupled to the vertical deflector plate of the Panoramic indicator so that a flat video response down to zero frequency with minimum distortion is possible.

The potentiometer, R32, controls the DC potential difference between the upper and lower vertical deflection plates, and, therefore, the *vertical position* of the electron beam.

The audio output is taken from the plate of the video amplifier, through a blocking condenser, to a 'phone jack at the rear of the chassis. The audio level is more than adequate for headset operation. Crystal headphones are recommended because of their high impedance.

### 5. SAWTOOTH GENERATOR AND AMPLIFIER.

The sawtooth voltage applied to the modulator is obtained from a "blocking grid" oscillator.

As the grid of the 6SN7 oscillator tube V7—the half connected to T3—is driven positive, the grid

blocking condenser, C21, is charged highly negative by grid current. As the grid makes its negative swing, the voltage across C21 keeps the grid at a high negative potential that blocks the tube. The blocking voltage gradually decays due to leakage of the condenser charge through the grid resistor, R20.

In the meantime, while the tube is blocked, the plate condenser, C20, charges slowly through the linear portion of the charging curve, until the charge on the *grid condenser* has decayed sufficiently to allow the tube to conduct. In the process of conduction the plate condenser is rapidly discharged and the whole process is repeated so that a sawtooth voltage appears across the plate condenser.

The frequency of the sawtooth is dependent upon the rate at which the grid blocking condenser discharges through the grid resistor. R18 and C20 also affect the frequency. The values are chosen so as to produce a sawtooth frequency of approximately 25 to 30 cycles per second.

By introducing the power line frequency into the grid input circuit, through divider resistors R19 and R21, the sawtooth is locked or synchronized to one-half the power line frequency.

The sawtooth voltage developed across C20 is applied and amplified by the other half of the 6SN7. The output at the plate of this section is capacitively coupled to the horizontal deflection plate of the cathode-ray tube. The application of the sawtooth wave to the horizontal deflection plate causes the electron beam to sweep in one direction across the fluorescent face of the tube as the sawtooth voltage rises, and then snap back with the rapid decay of the sawtooth. Due to the persistence of vision, a horizontal baseline is apparent.

HORIZONTAL POSITIONING of the baseline is possible through the use of potentiometer, R30, which controls the D.C. potential difference between the left and right horizontal deflection plates.

Another sawtooth output is taken off the cathode of the section and this is applied through potentiometer R23, the SWEEP PAD, and the SWEEP-WIDTH control, R22, to the modulator tube. The function of the SWEEP PAD is to proportion the proper amount of sawtooth across the sweepwidth control so that a 200KC oscillator excursion is obtained when the SWEEPWIDTH control is set to maximum.

The fact that the same sawtooth voltage is used to swing both the electron beam and the oscillator frequency simultaneously is necessary for understanding the development of the Panoramic display.



Since a given instantaneous value of sawtooth voltage will correspond to one particular horizontal location on the tube face and to one particular frequency of the oscillator, signals across the band, being examined, will be spread across the face of the tube, in exactly the same manner that the signals would be spread across the range of a tuning dial.

## 6. POWER SUPPLY AND PANORAMIC INDICATOR CIRCUIT.

The power supply consists of a positive supply used for all of the tubes and to furnish part of the

cathode-ray tube voltage, and a low-current high voltage negative supply makes up the rest of the cathode-ray tube supply. The INTENSITY control, R34, varies the brightness of the trace and the FOCUSING control, R38, is necessary to set the beam to as small a spot as possible. A VR-105 regulator tube is used to stabilize the screen voltage on the modulator tube.

## 7. SCHEMATIC DIAGRAM.

A complete schematic of the PANADAPTOR is shown in Figure 36.

# SECTION V MAINTENANCE AND SERVICE

## 1. ALIGNMENT.

a. NEED FOR ALIGNMENT.—Unless it is *definitely* established that the alignment is incorrect, no adjustments of the tuned circuits should be made.

Provided that all the tubes are good and the voltages are as specified in the Voltage Chart, the following symptoms indicate misalignment.

(1) LOW SENSITIVITY.—Indicated by the lack of “grass” on the screen, with the *Gain* Controls at maximum and the PANADAPTOR connected to a “live” receiver.

(2) CENTER FREQ. CONTROL LACKS FULL RANGE.—It cannot shift a signal through the entire screen baseline.

(3) SCREEN CALIBRATION ERROR.—A discrepancy of more than 15% exists between signal frequency and screen scale indication of frequency.

(4) OVERALL RESPONSE OF MORE THAN THREE PEAKS. Signal deflection shows more than peak heights as it moves across the screen when the receiver is tuned.

### Note

The R.F. stages in the receiver must be correctly aligned for proper PANADAPTOR operation.

(5) NON-SYMMETRICAL DEFLECTION SHAPE FOR AN UNMODULATED SIGNAL. Usually due to I.F. oscillation or incorrect alignment of the PANADAPTOR I.F. transformer.

a. ALIGNMENT PROCEDURE.—Allow the PANADAPTOR to reach operating temperature to assure stable operation. This may require 10-20 minutes. Adjust the screwdriver controls, INTENSITY and FOCUS, for optimum brightness and

sharpness of the baseline trace. Note: Reduction of the intensity and proper adjustment of the Focus control produces a sharp baseline. Bring the baseline trace in coincidence with the lowest horizontal line on the screen by means of the VERTICAL POSITION Control.

Adjust the HORIZONTAL POSITION Control so that the baseline is approximately centered along the horizontal axis.

Determine whether the horizontal sweep is synchronized to half the line of frequency by introducing hum into the grid (pin #2) of the 6SQ7 (use finger or screwdriver). A double hump should appear on the baseline if the circuit is operating correctly. If it does not, refer to the Troubleshooting Chart.

The Panoramic screen is used as the alignment indicator. Signals should be kept below the saturation level by limiting the signal generator output voltage.

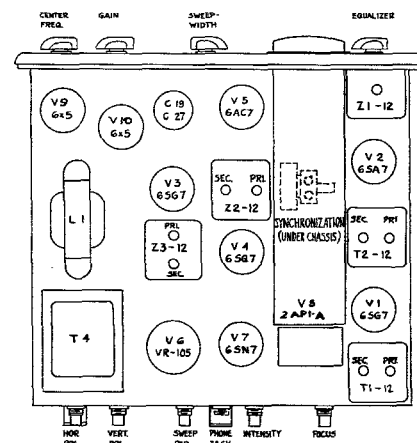

Figure 34. Top View of Chassis

Alignment of	Signal Generator Output	Position of Controls	Procedure
I.F. Amplifier	226KC unmodulated to pin #8 of V2.	SWEEPWIDTH at zero position. CENTER FREQ. turned extreme counter-clockwise.	Entire baseline deflects upward. Adjust the trimmers in the I.F. transformers (Z2-12, Z3-12) for maximum deflection.
F.M. Oscillator	455KC (or I.F. of the receiver) unmodulated to pin #8 of V2.	SWEEPWIDTH at maximum. SWEEP PAD set half way. CENTER FREQ. at center or zero position.	A "pip" will appear on the screen. Adjust the trimmer in the oscillator transformer Z1-12, to bring "pip" to the center of the screen. Turn the SWEEPWIDTH control to almost zero for more accurate indications of proper trimmer adjustment. Return the SWEEPWIDTH control to maximum and adjust the HORIZONTAL POSITION control so that the "pip" is directly over the zero mark on the screen.
Linearity of Sweep	355KC - 555KC (or I.F. of the receiver $\pm 100$ KC) unmodulated to pin #8 of V2.	SWEEPWIDTH at maximum. CENTER FREQ. at center or zero position.	Set the signal generator for 555KC (or receiver I.F. +100KC). Bring the "pip" to the -100KC mark with the SWEEP PAD. Shift the generator frequency to 355KC (or receiver I.F. -100KC). The "pip" should be at the +100KC mark. If the linearity is incorrect, the deflections appear more than 10KC or $\frac{1}{2}$ division from each end with 455KC or I.F. deflection in the center of the screen. Correction is possible by trial spacing of the grid and plate leads of the reactance modulator, V5. If correction does not result, adjust the oscillator trimmer (Z1-12) and the CENTER FREQ. control. If after the adjustment is made the CENTER FREQ. knob is off center for a center frequency deflection at the zero mark on the screen, unscrew and reset the knob to the center position.
R.F. Bandpass Amplifier	365KC - 545KC (or I.F. of receiver) $\pm 90$ KC) unmodulated to a 50K resistor in series with the full length of input cable to the PANADAPTOR.	Set GAIN to maximum. Turn EQUALIZER fully clockwise. Set CENTER FREQ. control to zero.	Set the signal generator at 545KC (or receiver I.F. +90). Back off the side side trimmers on both R.F. transformers (T1-12, T2-12) and align the top trimmers for maximum deflection. Shift signal generator to 365KC (or receiver I.F. -90) and tune the two side trimmers for maximum deflection. Repeat both adjustments. The ratio of the peak to center heights (peak to valley) should be greater than 20:1.

## 2. REMOVAL AND INSERTION OF THE CATHODE-RAY TUBE.

### a. TUBE REMOVAL.

(1) Remove the rubber strip around the tube shield. Seize one side of its seam, underneath the shield, and gently pull it away from the front of the panel.

(2) Push the shield slightly forward through the panel.

(3) Carefully pry the tube out of its socket with a screwdriver.

(4) Remove the grommets at the rear end of the shield.

(6) Tilt the rear end of the shield upward and remove the tube.

### b. TUBE INSERTION.

(1) Place the tube into the shield. Position the Panoramic screen in the shield.

(2) Insert the shield into the front panel.

(3) Place the rubber grommet in the side holes of the shield. The *long* end of the grommet goes inside the shield.

(4) Line up the shield and tube key with the socket.

(5) Insert the tube into the socket. To do this, hold the socket bracket and gently push on the *center* of the Panoramic screen.

(6) Ease the rubber strip into the clearance between the shield and front panel. Start at the bottom of the shield and gradually work the strip completely around the shield.

(7) Fit the Panoramic screen snug against the tube by gently pushing the shield back into the chassis.

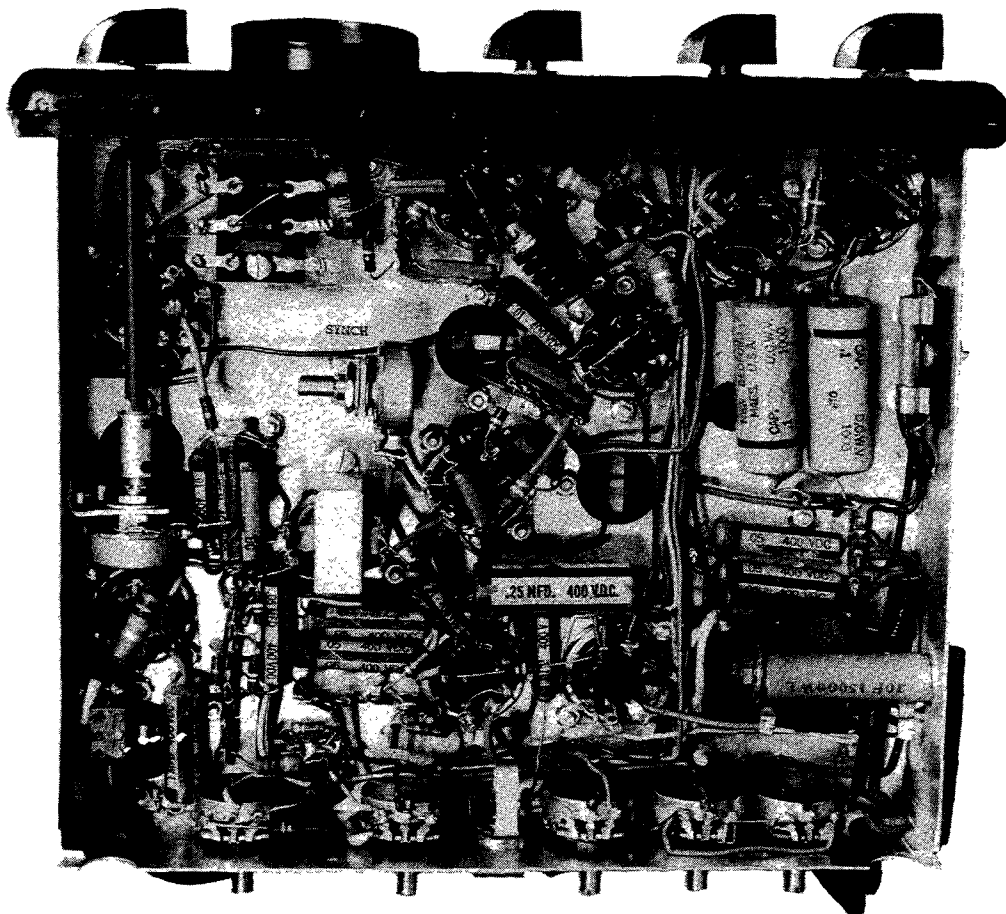

Figure 35. Bottom View of Chassis

### 3. TROUBLE SHOOTING CHART.

<u>Symptom</u>	<u>Causes and Cures</u>	<u>Symptom</u>	<u>Causes and Cures</u>
1. No illumination of the cathode ray tube, V8.	<ol style="list-style-type: none"> <li>1. AC power is off.               <ol style="list-style-type: none"> <li>a. See if tubes are lit.</li> <li>b. Fuse inside chassis burned out.</li> <li>c. Check ON-OFF switch.</li> </ol> </li> <li>2. INTENSITY and FOCUS controls out of adjustment.</li> <li>3. Defective cathode ray tube, or rectifiers V9, V10.</li> <li>4. Defective high voltage power supply.</li> <li>5. Tubes not seated properly in sockets.</li> <li>6. Shorted filter condensers C17, C18.</li> <li>7. Open resistors R16, R34.</li> </ol>	5. Increase SWEEPWIDTH control to maximum sweep.	
2. Baseline trace cannot be made sharp and bright.	<ol style="list-style-type: none"> <li>1. AC power input below 115V.</li> <li>2. Check high voltage power supply (V10).</li> <li>3. Defective cathode ray tube.</li> <li>4. Check condition of INTENSITY and FOCUS controls for possible opens.</li> <li>5. Check resistance of R16, R36, R37 and R39.</li> </ol>	7. Whole baseline moves vertically when receiver is tuned.	<ol style="list-style-type: none"> <li>1. F.M. sweep is not operating, and set behaves as though the SWEEPWIDTH control is set at zero. Check V5. Use an oscilloscope to check sawtooth at pin #4 of V5.</li> <li>2. Strong local stations coming through the receiver and beating against one another in the input stages of the PANADAPTOR to produce 226KC. Remedy would be to align receiver or install wave traps.</li> </ol>
3. Baseline trace cannot be made to coincide with screen baseline.	<ol style="list-style-type: none"> <li>1. Check high voltage power supply (V10).</li> <li>2. Check V4 if unable to get vertical position.</li> <li>3. Check R31.</li> <li>4. Check the voltage on the cathode ray tube deflection plates against the voltages specified on the Voltage Chart.</li> </ol>	8. Baseline remains at top of the screen regardless of tuning.	<ol style="list-style-type: none"> <li>1. I.F. amplifier may be oscillating. Change V3, V6. Check C4, C28. Compare V3 voltage against voltage chart.</li> <li>2. Video amplifier V4 may be inoperative. Change V4. Compare V4 voltages against Voltage Chart.</li> </ol>
4. Stationary spot on the screen.	<ol style="list-style-type: none"> <li>1. Check V7.</li> <li>2. Trace the sawtooth voltage with an oscilloscope from the blocking oscillator V7 to V8.</li> <li>3. Check R18, R20.</li> </ol>	9. Low gain. Able to hear weak signals but cannot see them on PANADAPTOR screen.	<ol style="list-style-type: none"> <li>1. Check all tubes. Most likely to be weak V3, V4.</li> <li>2. Check voltages, especially screen voltage of V3.</li> <li>3. Misaligned I.F. transformers. <i>Note: Do not attempt alignment until absolutely certain that alignment is at fault.</i></li> </ol>
5. Jumpy baseline or flickering images.	<ol style="list-style-type: none"> <li>1. Sawtooth Generator is not synchronized to half the line frequency. Feed AC from Pin No. 7 of V4 through a 500 mmf condenser to Pin No. 2 of the same tube. Adjust the Synchronization potentiometer under the chassis until two stationary peaks appear on the screen. Remove the AC voltage after adjustment is completed.</li> </ol>	10. Symptoms of misalignment. <ol style="list-style-type: none"> <li>a. Low gain.</li> <li>b. "Pips" too wide.</li> <li>c. The double peaked response of the band pass amplifier is not peaked at points 10KC from each end of the scale.</li> <li>d. Frequency range of signals on the screen is other than 200KC at maximum sweep-width.</li> <li>e. Range of the CENTER FREQ. control is less than 200KC.</li> <li>f. Pip generated by an unmodulated signal is non-symmetrical.</li> </ol>	<ol style="list-style-type: none"> <li>1. Do not attempt alignment until the set has been thoroughly checked for faults. Be sure that the error limits, as given in the specifications, for the PANADAPTOR, are exceeded before concluding that alignment is necessary.</li> </ol>
6. No signals.	<ol style="list-style-type: none"> <li>1. Check connection to receiver.</li> <li>2. Turn up GAIN control.</li> <li>3. Check operation of the receiver.</li> <li>4. Test PANADAPTOR for center deflection with a signal generator set at 455KC (or I.F. of receiver) to the input (disconnected from receiver).</li> </ol>		

#### 4. VOLTAGE CHART—1000 ohms per volt D.C. and A.C.

Circuit Symbol	Type	Function	P I N N U M B E R S										
			1	2	3	4	5	6	7	8	9	10	11
V1	6SG7	R. F. Amplifier	0	0	18	0	18	110	6.3ac	380			
V2	6SA7	Converter	0	0	380	105	-.1	.05	6.3ac	-1°			
V3	6SG7	I. F. Amplifier	0	0	2	0	2	110	6.3ac	380			
V4	6SQ7	Detector, Video Amplifier	0	-.05	0	---	-.05	130	6.3ac	0			
V5	6AC7	Reactor	0	0	0	0	6†	105	6.3ac	370			
V6	VR105	Voltage Regulator	---	0	380	---	105	---	380	---			
V7	6SN7	Sawtooth Generator and Amplifier	0	90	6°	-10°	20°	0	6.3ac	0			
V8	2AP1A	CRT Indicator	-380°†	-380°†	140°	-190°†	---	50°	170°	180°†	60°†	-380°†	-380°†
V9	6x5	L. V. Rectifier	0	0	270ac	680ac	270ac	---	6.3ac	390ac			
			---	---	---	-640	---	---	---	390			
V10	6x5	H. V. Rectifier	0	0	680ac	340ac	680ac	170ac	6.3ac	200ac			
			---	---	-640	-380	-640	105	---	---			

Note:—Gain at min.; Sweepwidth at max. All other controls normal position.

°Voltage reading varies according to scale used.

†Reading varies with control setting.

#### 5. VOLTAGE CHART—20,000 ohms per volt D.C. 1000 ohms per volt AC Line Voltage 115 volts.

Circuit Symbol	Type	Function	P I N N U M B E R S										
			1	2	3	4	5	6	7	8	9	10	11
V1	6SG7	R. F. Amplifier	0	0	20	0	20	120	6.3ac	380			
V2	6SA7	Converter	0	0	380	105	-.275	.05	6.3ac	-1.2°			
V3	6SG7	I. F. Amplifier	0	0	2.4	-.05	2.4	120	6.3ac	380			
V4	6SQ7	Detector, Video Amplifier	0	-.25	0	---	-.25	150	6.3ac	0			
V5	6AC7	Reactor	0	0	0	5°	6†	105	6.3ac	370			
V6	VR105	Voltage Regulator	---	0	380	---	105	---	380	0			
V7	6SN7	Sawtooth Generator and Amplifier	.1°	160	7.7	-40°	77	0	6.3ac	0			
V8	2AP1A	CRT Indicator	-500†	-500†	150	-300†	---	125	195	200†	120°†	-500†	-500†
V9	6x5	L. V. Rectifier	0	0	270ac	680ac	270ac	---	6.3ac	390ac			
			---	---	---	-690	---	---	---	390			
V10	6x5	H. V. Rectifier	0	0	680ac	340ac	680ac	107ac	6.3ac	200ac			
			---	---	-690	-510	-690	105	---	---			

Note:—Gain at min.; Sweepwidth at max. All other controls normal position.

°Voltage reading varies according to scale used.

†Reading varies with control setting.

## 6. RESISTANCE CHART.

Circuit Symbol	Type	Function	P I N N U M B E R S										
			1	2	3	4	5	6	7	8	9	10	11
V1	6SG7	R. F. Amplifier .....	0	0	10K	18	10K	40K	∞	32K			
V2	6SA7	Converter .....	0	0	32K	38K	20K	3.6	∞	1.5 meg			
V3	6SG7	I. F. Amplifier.....	0	0	510	1 meg	510	40K	∞	32K			
V4	6SQ7	Detector, Video Amplifier.	0	510K	0	---	510K	180K	∞	0			
V5	6AC7	Reactor .....	0	0	0	800K†	1200	40K	∞	38K			
V8	2APIA	CRT Indicator .....	---	0	32K	---	40K	---	32K	1.1 meg			
V7	6SN7	Sawtooth Generator and Amplifier .....	2 meg	500K	20K	900K†	3 meg	0	∞	0			
V8	2APIA	CRT Indicator .....	2.5 meg	2.5 meg	180K	1.5 meg†	---	3 meg	60K	120K†	3 meg	2.5 meg†	2.5 meg
V9	6x5	L. V. Rectifier .....	0	0	150	3 meg	150	---	∞	32K			
V10	6x5	H. V. Rectifier .....	0	0	3 meg	2.5 meg	3 meg	40K	∞	100			

∞ Less than 1 ohm.

Note:—Gain at min.; Sweepwidth at max. All other controls normal position.

K = 1000 ohms.

Resistances are given in ohms.

## 7. LIST OF SPECIAL COMPONENTS.

Circuit Symbol	Name and Description	Part Number Panoramic
T1-12	Input R.F. Bandpass Transformer .....	L1114 (T1-5215)
T2-12	Output R.F. Bandpass Transformer .....	L1114A (TI-5216)
Z1-12	Oscillator Transformer .....	T1-5219
Z2-12	Input I.F. Transformer .....	L1115 (T1-5217)
Z3-12	Output I.F. Transformer .....	L1115A (TI-5218)
T3	Sawtooth Generator Transformer .....	T1-5114
T4	Power Transformer .....	T2-5817
L1	Filter Choke .....	L1-5209
L2	R.F. Choke .....	L1113

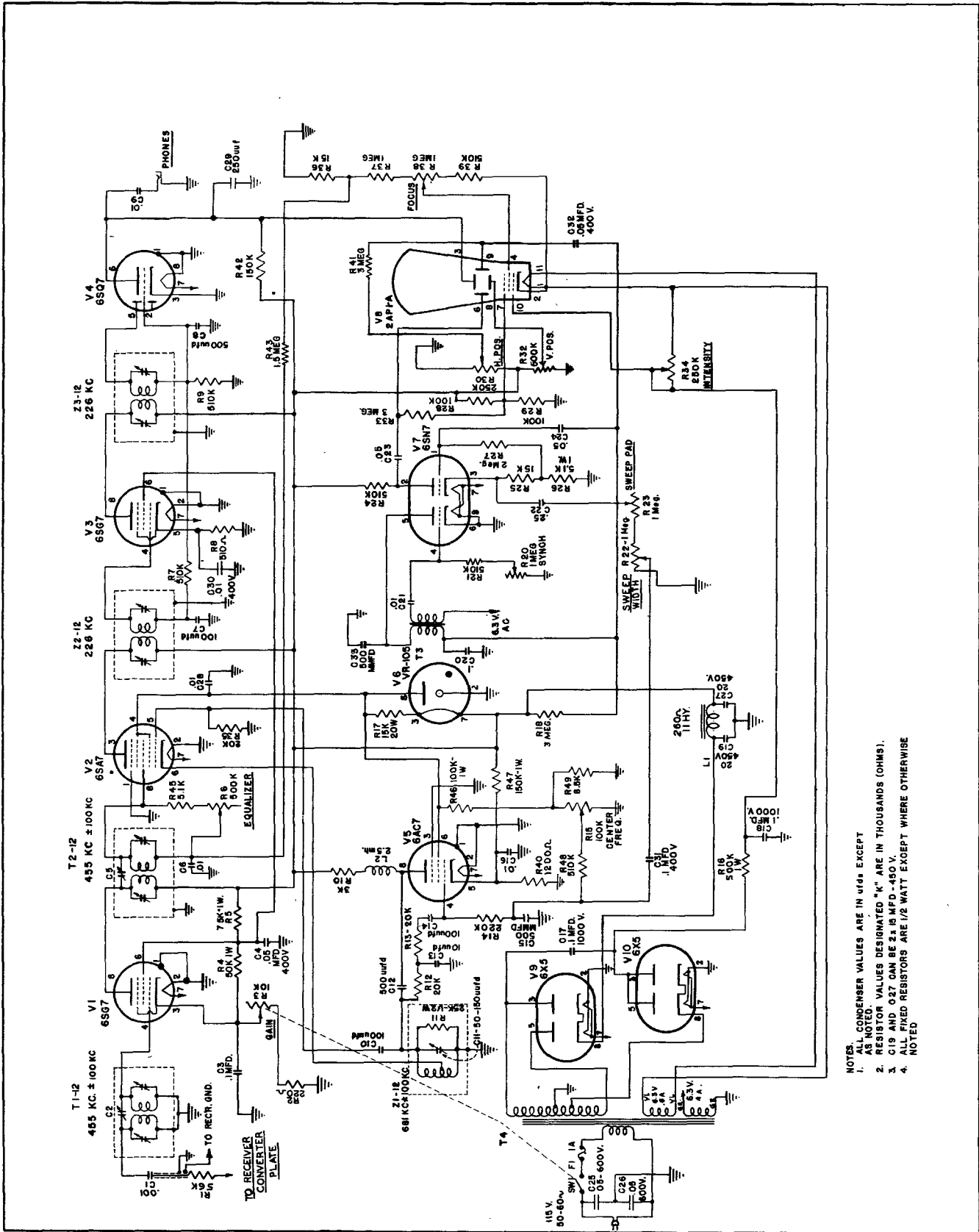

- NOTES:
1. ALL CONDENSER VALUES ARE IN  $\mu$ Fs EXCEPT AS NOTED.
  2. RESISTOR VALUES DESIGNATED "K" ARE IN THOUSANDS (OHMS).
  3. C19 AND C27 CAN BE 2x10 MFD - 450 V.
  4. ALL FIXED RESISTORS ARE 1/2 WATT EXCEPT WHERE OTHERWISE NOTED.

Figure 36. Circuit Diagram. PANADAPTOR Model PCA-2, Type T-200